

**Urban Safety Management:
Guidelines for Developing Countries**

by A Quimby, B Hills, C Baguley and J Fletcher

**PR/INT/254/2003
DFID**

PROJECT REPORT PR/INT/254/03

Urban Safety Management: Guidelines for Developing Countries

By A Quimby, B Hills, C Baguley and J Fletcher

Subsector:	Transport
Theme:	T1
Project Title:	Development of an urban road safety management approach
Project Reference:	R 7476

Approvals	
Project Manager	<input type="text"/>
Quality Reviewed	<input type="text"/>

Copyright TRL Limited 2003

This document has been prepared as part of a project funded by the UK Department for International Development (DFID) for the benefit of developing countries. The views expressed are not necessarily those of DFID.

The Transport Research Laboratory and TRL are trading names of TRL Limited, a member of the Transport Research Foundation Group of Companies.

TRL Limited. Registered in England, Number 3142272. Registered Office: Old Wokingham Road, Crowthorne, Berkshire, RG45 6AU, United Kingdom.

CONTENTS

EXECUTIVE SUMMARY	1
1 INTRODUCTION.....	4
1.1 What is urban safety management?	4
1.2 USM research background.....	7
1.3 Whole urban area and local area safety schemes	9
1.4 Defining the study area	9
1.5 Why develop the USM approach for developing countries?	10
1.6 How should USM be applied in developing countries?	11
1.6.1 Co-ordinating a USM project.....	11
1.6.2 Applying the USM methodology.....	11
1.7 Focussing on the urban poor.....	12
1.8 Overview to the Guidelines	12
1.9 Case studies	14
1.9.1 Why were these case studies chosen?	14
1.9.2 What do the case studies illustrate that other cities could follow?	15
1.9.3 Limitations	16
2 BACKGROUND CONCEPTS AND ISSUES.....	17
2.1 Engineering and Planning	17
2.1.1 Road hierarchy.....	17
2.1.2 Safety Conscious Design	19
2.2 Road User Behaviour, Education and Enforcement.....	20
2.2.1 Factors affecting road user behaviour	20
2.2.2 Identifying the causes of behaviour	21
2.2.3 Social and Cultural issues.....	22
2.2.4 Changing behaviour through training and education	22
2.2.5 Changing behaviour through Traffic Law and Enforcement.....	23
2.3 Focussing on the urban poor	23
3 PROBLEM ANALYSIS: ASSESSMENT OF NETWORK SAFETY.....	26
3.1 Objectives.....	26
3.2 Sources of information	26
3.2.1 Police ledger entries	27
3.2.2 Local knowledge of hazardous locations.....	27
3.2.3 Surveys of stakeholders and local road users.....	27
3.2.4 Conflict studies	27
3.2.5 Insurance, hospital and ambulance data.....	27
3.3 Examples of analyses	27
3.3.1 Location of accidents and perceived problems	27
3.3.2 Cross-tabulation analyses	31
3.3.3 Stick diagrams.....	34
3.3.4 Monitoring study areas	35
4 PROBLEM ANALYSIS: COLLECTING SURVEY DATA.....	37
4.1 Engineering related data collection	37
4.1.1 Types of engineering related data that may need to be collected	37
4.1.2 Establish a link/node system over the area.....	38
4.1.3 Road classification: Identifying the present road hierarchy	39
4.1.4 Vehicle classification system	40
4.1.5 Land use survey map	41
4.1.6 Detailed link inventory.....	42
4.1.7 Detailed junction inventory form.....	43
4.1.8 Detailed parking inventory form	45

4.1.9	Traffic counting and classification	46
4.1.10	Moving car observer method for measuring traffic flow and journey speeds.....	49
4.1.11	Counting pedestrians	50
4.1.12	Speed Surveys.....	53
4.1.13	Radar and laser speed guns	54
4.1.14	Manual short-base method.....	54
4.1.15	Output.....	55
4.1.16	Recording hazardous and abnormal features.....	55
4.1.17	Use of video.....	57
4.2	Further Behaviour, Education and Enforcement related data.....	57
4.3	Identification and prioritisation of the poor.....	57
5	CONSULTATION.....	61
5.1	Introduction.....	61
5.2	Why consult?.....	61
5.3	Who to consult?.....	63
5.3.1	Introduction.....	63
5.3.2	The public.....	63
5.3.3	Stakeholders and other ('interest') groups.....	64
5.3.4	Inclusion of the absolute poor	65
5.3.5	Local media	66
5.4	When to consult?.....	66
5.5	What to consult on?.....	68
5.5.1	Introduction.....	68
5.5.2	The analysis (problem identification) and strategy phases.....	68
5.5.3	The planning and design phases	68
5.5.4	Implementation phase	69
5.5.5	Assessment phase	69
5.6	How to consult?.....	70
5.6.1	Introduction.....	70
5.6.2	Review of literature and previous experience	70
5.6.3	Conducting surveys	71
5.6.4	In-depth (or semi-structured) interviews.....	72
5.6.5	Focus groups.....	73
5.6.6	Meeting and exhibitions	73
5.6.7	Consulting the community (Participatory Learning and Action))	73
5.7	How do you analyse the findings?	76
5.8	Resolving conflicts.....	77
5.9	Summary guidelines on consultation	77
6	DECISION-MAKING FOR SOLUTIONS.....	78
6.1	Re-appraising the Network	78
6.1.1	Introduction.....	78
6.1.2	Analysis phase	78
6.1.3	Establishing or modifying the road hierarchy	79
6.1.4	Assessment of roads within the hierarchy.....	80
6.1.5	Urban safety review	80
6.2	The Strategy Phase.....	83
6.2.1	Engineering and Planning Strategies.....	83
6.2.2	National and Local Education and Enforcement Policies	84
6.2.3	Education strategies	85
6.2.4	Enforcement Strategies	85
6.2.5	Special needs of the Urban Poor	85
6.3	The Planning Phase	86

6.3.1	Engineering and planning schemes	86
6.3.2	Planning Education schemes.....	87
6.3.3	Planning Enforcement schemes	87
6.3.4	Initial Prioritisation and Cost-Benefit Estimates of Solutions	88
6.3.5	Consultation	90
6.4	Appropriate engineering solutions.....	90
6.4.1	Improving road user behaviour	90
6.4.2	Provision of facilities for road users	91
6.4.3	Minimising crash severity.....	93
6.5	Examples of education, training and publicity solutions	111
6.5.1	Road Safety Education (RSE) in schools.....	111
6.5.2	Training	112
6.5.3	Mass media publicity programmes.....	112
6.6	Examples of traffic police enforcement solutions	114
6.6.1	Speeding, red light enforcement and other violations.....	114
6.6.2	Poor overtaking/Aggressive driving/Close following	114
6.6.3	The use of technology	114
6.6.4	Penalty point system.....	115
6.6.5	Roadside safety checks.....	115
6.6.6	Defective vehicles.....	115
6.7	Changing behaviour through insurance schemes	115
7	FINAL DESIGN AND IMPLEMENTATION PHASE	116
7.1	Designing measures for the solutions	116
7.1.1	Safety and Poverty Conscious design	116
7.1.2	Legal issues	117
7.1.3	Further consultation	117
7.2	Road safety audit.....	117
7.2.1	The need for road safety auditing	117
7.2.2	Aims of the safety audit	117
7.2.3	Organisation of the audit.....	118
7.2.4	When to carry out the audit.....	118
7.2.5	The audit task.....	118
7.3	Implementation.....	119
7.3.1	Staged implementation	119
7.3.2	Experimental installation.....	119
7.3.3	Publicity	119
7.3.4	Safety at roadworks	119
7.3.5	Final safety audit	120
7.3.6	Opening the scheme.....	120
7.3.7	Implementation log	120
8	ASSESSMENT: MONITORING AND EVALUATION.....	121
8.1	Monitoring.....	121
8.1.1	The first few days and weeks.....	121
8.1.2	Repeated Surveys	121
8.1.3	Monitoring accidents.....	121
8.1.4	Effects on other areas.....	123
8.1.5	Logging the monitoring measures.....	123
8.2	Before-and-After Studies	123
8.2.1	Timing of the <i>Before</i> measurements	123
8.2.2	Timing of the <i>After</i> measurements	124
8.2.3	Changes in the <i>After</i> period	124
8.2.4	Control data.....	124
8.2.5	The statistical techniques	125

8.2.6	Conflict studies	125
8.3	Evaluation.....	125
8.3.1	The purpose and scope of evaluation	126
8.3.2	Evaluation of traffic speed data.....	126
8.3.3	Factors affecting accident frequencies.....	127
8.3.4	Before and after periods	129
8.3.5	Standard statistical tests applied to accident changes	130
8.3.6	Economic evaluation.....	131
8.4	Final consultation and reporting.....	132
8.5	Summary guidelines on evaluation	132
9	CONCLUDING REMARKS.....	133
10	ACKNOWLEDGEMENTS	135
11	REFERENCES.....	136
	APPENDIX A Defining urban poverty	140
	APPENDIX B STATISTICAL TESTS.....	143
B.1	Student's t-test for comparison of samples.....	143
B.1.1	Table of t-distribution.....	145
B.2	Kolmogorov-Smirnov test	146
B.2.1	Table of χ^2	148
B.3	The Tanner k test.....	149
B.4	The Chi-Squared test	150
B.5	Test for statistical significance between two proportions	152
B.6	Regression-to-the-mean correction	154
	ANNEXE 1	
	Applying the Urban Safety Management approach in Bangalore, India: A case study	
	ANNEXE 2	
	Applying the Urban Safety Management approach in Cirebon, Indonesia: A case study	

Executive Summary

Close to one million people are killed on the world's roads every year with at least 70% of these deaths occurring in developing countries. The proportion of accidents occurring in towns and cities is rising due to the rapid urbanisation of many developing countries. For example, in Kenya, in 1980, the urban population accounted for only 15 per cent of Kenya's total population. However, it is estimated that it reached 33 per cent in 2000, and will reach 41 per cent by 2010.

These guidelines have been developed for local and regional highway authority officers in developing countries who have a responsibility for road safety issues in urban areas. The objective is to give these agencies the tools to implement Urban Safety Management (USM) techniques, enabling them to tackle road safety problems on a broad front, including engineering, education, publicity campaigns and enforcement.

The research programme supporting the development of these guidelines was funded as part of the UK's Department for International Development (DFID) Knowledge and Research (KaR) programme. The objective of the research was to explore the use of the USM approach that has been successfully used in Europe, and provide support and guidance for its application in developing countries. The DFID programme has an underlying poverty and livelihoods focus and the need to address these concerns has been incorporated at various stages of the USM process proposed in the manual.

The intention is that local authorities in developing countries should adapt the procedures outlined in the manual to their own needs and circumstances, perhaps adding or deleting stages of the process, or adopting radically different solutions to those illustrated. This is because there can be marked differences both between countries and within countries in the traffic mix, road user behaviour and the road infrastructure found in urban areas. For many developing countries, the USM schemes introduced will therefore be very different from the kinds of schemes currently being successfully employed in Europe.

What is urban safety management?

USM is a systematic approach to road accident prevention and casualty reduction in a town or city, bringing together a variety of disciplines and views to create an integrated approach. It can be thought of as the coming together of safety, traffic management, education, enforcement and transport policies to reduce accidents. In doing this, USM should create a carefully planned approach, based on the views and opinions of everyone, from the public to practitioners and politicians. This differs from historic engineering approaches that simply integrated the views of the associated professionals.

Road accidents in urban areas often fall into one of two categories: they may be concentrated in 'black spot sites' ('accident clusters'), or 'scattered' randomly throughout an area. Measures and methods to deal with clustered accidents are well established and well known; however, scattered accidents pose more of a problem to road safety practitioners. The USM approach uses an area-wide and multi-disciplinary approach that considers safety in the whole area to reduce these randomly scattered accidents. The cornerstone of the approach is to try and maximise safety (and the feeling of safety) and to improve the physical environment in residential areas, whilst at the same time improving the safety of the main roads.

The Manual

The process of developing and implementing a USM scheme can be divided into six phases:

- Analysis
- Strategy
- Planning
- Design
- Implementation
- Assessment

The manual discusses in detail the approach and techniques for each of these phases with many illustrated examples. The need for consultation and participation from the beginning to the end of the process is stressed.

The USM technique can be applied at two main strategic levels:

- a small 'local' area. Such a Local Area Safety Schemes (LASS) strategy can be gradually extended across the study area but initially kept small so as to make the schemes manageable in terms of finances and resources. Alternatively, they can be used as experimental trials - to evaluate and monitor measures - before defining and adopting the approach over a larger area.
- the whole town or city. A Whole Urban Area Safety Scheme (WUASS) requires broad appraisals of the current and possible future functional hierarchy of main roads, local distributor roads and access roads with associated routes for pedestrians, cycles or other slow-moving vehicles. It also requires an assessment of accident occurrences, road user behaviour and the public perception of safety in different parts of the urban area.

The manual has two Annexes that describe two major case studies where these different levels of strategy were experimented with:

1. Bangalore – a local area scheme
2. Cirebon – a whole urban area scheme

Because the greatest practical experience has been gained with engineering and planning countermeasures in USM projects, the manual considers them at a rather greater length than other sectors; however, it is emphasised that major roles are played by education, publicity campaigns and enforcement in all USM schemes.

Focussing on the urban poor

There are three principle stages for incorporating poverty into urban safety management at the outset of any proposed programme:

1. Identification of appropriate methods for identification and prioritisation of the poor
2. Identification of areas on the network where the road safety of the poor is being compromised.
3. Forecasting potential impact of road safety interventions on the poor

An example of where the needs of road safety and the poor might have conflicting interests is where street vendors block footpaths. If the accident analysis shows there is a need to clear the footpaths, then the remedial measure programme adopted

should attempt to nullify any adverse effects on the livelihoods of the vendors; for example, by creating special areas within or adjacent to the footpath for them to continue selling their wares without loss of sales.

It is in the nature of USM projects to focus upon the needs of the most vulnerable road users (pedestrians, cyclists etc) because these normally have the highest accident rates – and it is the urban poor that make up a high proportion of these groups in most developing country cities.

1 INTRODUCTION

These guidelines have been developed for local and regional highway authority officers in developing countries who have a responsibility for road safety issues in urban areas. The objective is to give these agencies the tools to implement Urban Safety Management (USM) techniques, enabling them to tackle road safety problems on a broad front, including engineering, education, enforcement and publicity campaigns.

Experience over the past fifty years in Europe has found that it is the application of engineering and planning measures that has often been the most successful approach in changing road user behaviour. Because of this, the greatest practical experience has been gained with this class of countermeasure in USM projects. As a consequence, this manual will consider engineering and planning measures at a rather greater length than other sectors; however, it must be stressed that this in no way diminishes the major roles to be played by education, enforcement and publicity campaigns in USM schemes.

The research programme supporting the development of these guidelines was funded as part of the UK's Department for International Development (DFID) Knowledge and Research (KaR) programme. The objective of the research was to explore the use of the USM approach that has been successfully used in more industrialised countries eg. TRL 'Safe City' Report (Lines, 1998); Guidelines for USM (IHT, 1990; European Commission - DUMAS, 2001), and provide support and guidance for its application in developing countries. It should be noted that the DFID programme has an underlying poverty and livelihoods focus and the need to address these concerns has been incorporated at various stages of the USM process proposed in this manual.

1.1 What is urban safety management?

USM is a systematic approach to road accident prevention and casualty reduction in a town or city, bringing together a variety of disciplines and views to create an integrated approach. It can be thought of as the coming together of safety, traffic management, education, enforcement and transport policies to reduce accidents, (Lines, 1996). In doing this, USM should create a carefully planned approach, based on the views and opinions of everyone, from the public to practitioners and politicians. This differs from historic engineering approaches that simply integrated the views of the associated professionals.

Road accidents in urban areas often fall into one of two categories; they may be concentrated in accident clusters ('hotspots'), or 'scattered' randomly throughout an area. Measures and methods to deal with clustered accidents are well established and well known; however, scattered accidents pose more of a problem to road safety practitioners. This is largely a result of needing greater awareness of the reasons for demand for travel and how to provide it safely. (Lines, 1996)

The USM approach uses an area-wide and multi-disciplinary approach that considers safety in the whole area to reduce these 'randomly' scattered accidents. USM involves all aspects of urban management: that is safety, enforcement, traffic, public transport, planning, engineering, environment, road construction and maintenance, development, health, education, welfare and land-use. The cornerstone of the approach is to try and maximise safety (and the feeling of safety) and to improve the physical environment in residential areas, whilst at the same time improving the safety of the main roads.

The IHT guidelines for Urban Safety Management (IHT, 1991) defines the principles of a good safety management strategy as one which:

- considers all kinds of road users, especially vulnerable road users (VRU's);
- considers the function of different kinds of road;
- formulates a safety strategy for the urban area as a whole;
- integrates existing accident reduction efforts into the strategy;
- relates safety objectives to other objectives for the urban area (e.g. transportation, land use planning);
- encourages all professional groups to help to achieve safety objectives;
- guards against adverse affects of other programmes on safety;
- uses the expertise of local road safety specialists;
- translates the strategy and objectives into local area safety schemes;
- monitors progress towards the safety objectives.

There are many elements in an urban safety strategy, as illustrated in Figure 1-1 taken from the DUMAS (Developing Urban Management and Safety) project research report (European Commission, 2001). It can be seen that bringing together the different bodies and the professional skills required is a substantial management task.

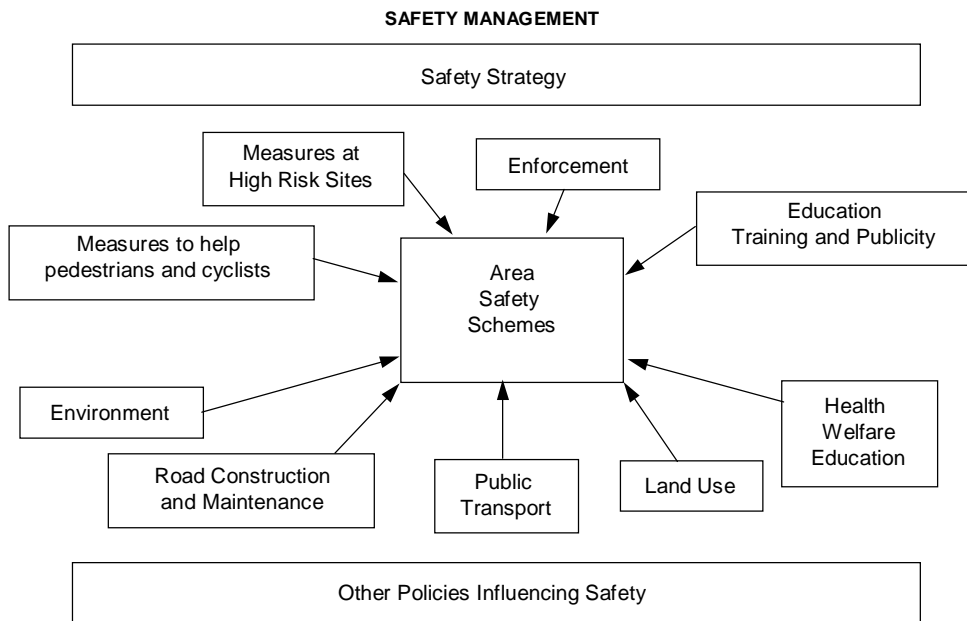

Figure 1-1: Elements of Urban Safety Management Approach

The adoption of an USM approach in developed countries has been shown to successfully reduce casualties in road traffic accidents in towns and cities by tackling accident problems on a broad front. It requires all interest groups to work closely together to raise the profile of safety in town management and planning.

The OECD, (1990) recommends the USM approach for the following reasons:

- In urban communities, multiple objectives are set concerning the promotion of local activities and the facilitation of traffic, often under competing interests. In this context, road safety problems cannot be treated separately.
- Accident occurrences are usually dispersed across an urban area, however this distribution is subject to fluctuation. Therefore, it would be misleading to design countermeasures for individual accident sites only.
- Safety measures are more effective if they form part of a comprehensive safety policy. To ensure maximum impact complimentary measures of a policy should be identified and co-ordinated.
- Traffic safety is often not a leading priority issue for local policy makers or citizens. Therefore, as well as direct safety initiatives, there is a need for embedding safety measures in other policies.
- Integrated safety programmes help local authorities compile a complete picture of existing problems before defining priorities for action.

1.2 USM research background

There has been much research concentrating on USM in the past and the method has proven successful; but USM has not found wide usage or been keenly adopted by practitioners. The IHT published USM Guidelines (IHT, 1991) following a research project led by TRL which applied the USM methods in five towns within the UK over a period of five years. The project showed that the installation of low-cost measures of various kinds applied on an area-wide basis reduced injury accidents by an average of 13 per cent. By introducing traffic calming in residential areas, injury accidents may be reduced by up to 50 per cent, with greater reductions recorded for child accidents (Lines, 1998). The DUMAS project was established to try to encourage the USM to be more universally used. DUMAS is a 1.2 million ECU project with ten partners from nine countries. The project started in January 1997 and brought together European experience and expertise on Urban Safety Management, including practical examples from ten towns.

The objectives of the DUMAS project were to encourage the implementation of USM and to produce robust frameworks for the design and evaluation of urban safety initiatives. DUMAS is achieving this by bringing together the existing knowledge on the effects of safety measures with the overall planning and management of urban safety programmes; particularly the interactions between engineers, politicians and the general public to produce 'Best European Practice' (Lines, 1999). DUMAS recommends a framework for the USM approach. This is summarised in Figure 1-2.

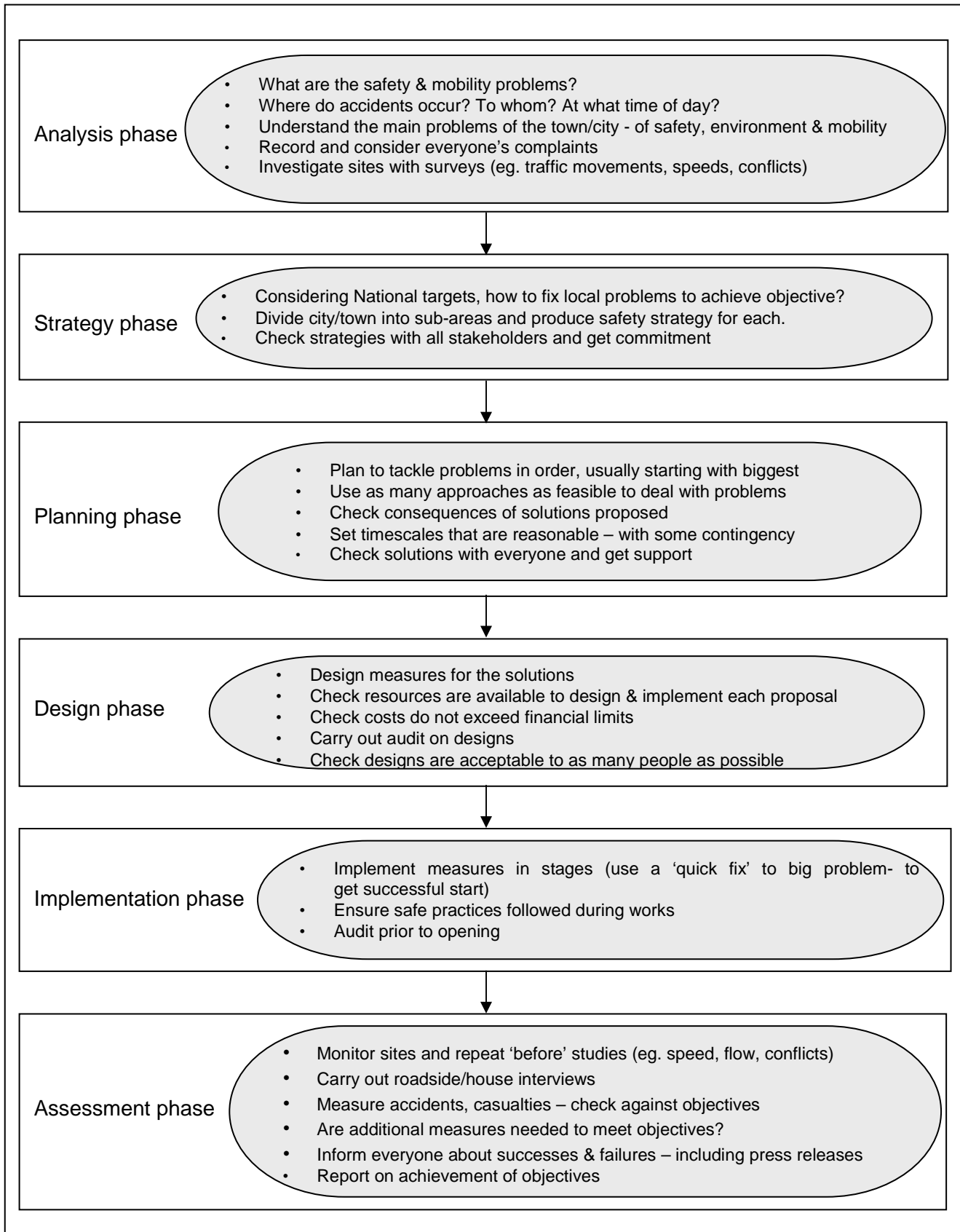

Figure 1-2: Stages in conducting a USM project (DUMAS recommendations)

Included as part of the DUMAS project is the UK Department for Transport (DfT) sponsored 'Safer City' project. 'Safer City' is a five year demonstration of applying the USM technique in Gloucester in the UK with the aim of reducing casualties by 30 per cent by the end of the project. (Mackie and Ward, 1996; DfT, 2001).

1.3 Whole urban area and local area safety schemes

The USM technique can be applied at a variety of strategic levels. One strategy is to apply it to a smaller 'local' area. Such Local Area Safety Schemes (LASS) strategy can be gradually extended across the study area but initially kept small so as to make the schemes manageable in terms of finances and resources. Alternatively, they can be used as experimental trials - to evaluate and monitor measures - before defining and adopting the approach over a larger area. This was the strategy adopted in the Bangalore Case Study which is reported as Case Study 2 in Annexe 2 of these guidelines.

In contrast to this Local Area approach, the 'higher level' Whole Urban Area Safety Scheme (WUASS) strategy (as adopted in the Cirebon Case Study, see Annexe 1) requires broad appraisals of:

- the current and possible future functional hierarchy of main roads, local distributor roads and access roads with associated routes for pedestrians, cycles or other slow-moving vehicles, and in some countries special motor cycle routes
- accident occurrences and public perception of safety on these various kinds of road in different parts of the urban area.

It also requires a dialogue among professional groups whose work impinges on road safety, through engineering, education, enforcement, environmental improvement, town planning, and the provision of public transport, emergency and welfare services. This dialogue should aim to gain widespread professional acceptance of safety initiatives, identify opportunities to improve safety through other initiatives, and introduce safety checking of the effects of other policies for the urban area.

In preparing the strategy, strong interaction between the transport and land use planning professionals is essential to enable resources to be drawn from a broader base than is available directly to road safety engineering teams. One of the main aims of the Whole Urban Area Safety Scheme is to identify and prioritise a series of Local Area Safety Schemes.

1.4 Defining the study area

The location and extent of the USM study area needs to be selected to fit the strategy intended and be large enough to facilitate monitoring of the scheme. The IHT (1991) suggests that the study area should be chosen to:

- Display the interaction between the measures;
- Show the redistribution of traffic;
- Have coherent communities with a suitable focus for consultation.

Areas to target include those recognised as having a poor safety record and / or areas where there is an opportunity to collaborate with other urban initiatives or road engineering programmes (IHT, 1990).

The UN-ESCAP Guidelines for Remote Area Transport and socio-economic Surveys (Barwell, 1988) recommend six inter-related activities to determine the study area:

1. Delineation of the survey area and major centres of activity;
2. Compilation of a survey area data base and comparative national and regional statistics;
3. Key informant surveys;
4. Village (survey area) mapping;
5. Village (survey area) leadership discussion;
6. Household interview surveys.

1.5 Why develop the USM approach for developing countries?

Traditional development thinking has been that the majority of the poorest people live in rural areas, and this, along with the desire not to accelerate the flow of people to urban areas (and the fact that most food is produced in the rural areas) has led historically to an emphasis on development work in rural rather than urban areas. Many cities in developing countries are failing to cope with the swell in urban populations due to migration from rural areas, and in many cases the increase in urban populations is expected to continue to grow exponentially. For example, in Kenya, in 1980, the urban population accounted for only 16 per cent of Kenya's total population. However, it is estimated that it reached 33 per cent in 2000, and will reach 43 per cent by 2010 (UN, 2002).

Cities are currently absorbing two thirds of the developing world's total population increase and it was estimated that the urban population of developing countries was 1.9 billion in the year 2000. Barrett, (1989), in a study of seven African countries found that approximately 70-80 per cent of road accidents occur in urban areas, whereas 'only' between 20-50 per cent of the national population live in such areas.

In developed countries, the impetus behind implementing the USM techniques has developed from a need to encourage choice in the mode of travel, sustainability of transport and environmental issues (Lines, 1996). In developing countries, the impetus is similarly driven by the need to improve sustainability and environmental issues but is primarily about integrating the many different travel modes into a safer, more systematic network. This is one of the greatest differences between the traffic mix in developed countries to that of developing nations. In developing countries, there are many more pedestrians, cyclists and motorcyclists and these vulnerable road users share the carriageway with heavy trucks, light trucks, cars and, in certain countries, auto-rickshaws and cycle-rickshaws. This highlights the potential conflict on these roads and the need for a USM approach to segregate or integrate conflicting modes appropriately.

Another reason for adapting the USM approach to developing countries is that the ideal engineering road hierarchy does not always match the functional use of the road. Even main distributor roads can serve the function of an access road with services and houses situated along them. There is a need, therefore, to adapt USM so that it can be successful in the developing world to reduce the number of deaths and injuries on roads in urban areas.

1.6 How should USM be applied in developing countries?

1.6.1 Co-ordinating a USM project

Urban Safety Management is a comprehensive and systematic approach to road accident prevention and casualty reduction in towns and cities. To formulate and execute such a comprehensive safety strategy, there is a need for a co-ordinating road safety agency that is multi-sectoral in nature. It should be charged with the responsibility for initiating and implementing broad safety policies and accident reduction programmes, such as driver training and testing, education, publicity, area-wide programmes aimed at selected groups of road users, monitoring, vehicle roadworthiness testing, securing funds for road safety actions, research etc. Even though “safety” is not exclusively within the sphere of traffic management the roads authority often becomes the lead agency as it plays a vital role in improving safety on its road network. The success of any local safety scheme will involve:-

- Strategic thinking and planning
- Local involvement
- Painsstaking attention to detail in the design with safety audit of prime importance

Having set up the management structure for safety responsibility and defined the overall objectives, the project team and sub-teams will need to carry forward USM principles through the analysis, strategy, design, implementation and assessment phases as shown in Figure 1-2.

1.6.2 Applying the USM methodology

The flow chart in Figure 1-2 gives an indication of how the standard USM approach should be considered and implemented, listing all the steps that should be taken. Because of the very different conditions found in some developing countries compared to typical developed countries, it may be necessary to adapt aspects of the USM methodology. However, the process itself can be described in similar phases.

- Firstly, the collection of accident and survey data is required in order that the eventual USM measures will be focussed on the roads and areas that need them. Whilst the main sources of accident data are the traffic police accident reports, these can be supplemented with local traffic police and traffic engineering knowledge of hazardous sites, interviews with local stakeholders and road users, and possibly hospital and ambulance records. For certain sites, it might be necessary to conduct conflict studies. The survey data can include the road geometry, road alignment data and other engineering measurements, as well as more general traffic data such as traffic counts, land use surveys and pedestrian counts. Additional behavioural surveys may need to be taken, such as running red light, overtaking or close following behaviour. It should then be used to define the engineering road hierarchy and the functional use of the road. This functional hierarchy should pay particular attention to pedestrian traffic counts and therefore give more priority to pedestrian movements around residential and commercial areas. It is imperative to establish at an early stage whether there are conflicts between the engineering road hierarchy and land use (functional use of road) and to establish priorities. What must be taken into account is that the engineering solutions proposed are appropriate, even though this may not be normally comparable with a good engineering road hierarchy. Thus many measures will be adapted to allow for access for vulnerable road users but must also allow for through-traffic should the road's role be that of a distributor. Education and enforcement programs, either in their own right or complementing the

engineering and planning proposals should also be considered in depth at this stage. For example, this might require appraisal of the techniques used in current road safety education in schools, or the enforcement strategies and tactics used by the traffic police.

Consultation with the local public and professionals (i.e. all stakeholders), encouraging their active participation, should take place throughout the project from start to finish, but is particularly important at this strategy stage. For a safety scheme to be successful it is important to have the support of the local people who will be using the road and living with the safety changes made; it is equally important to gain the support of local professionals who will implement the changes and monitor the scheme in the future. Some care should be taken in gaining support from the public, as it is very possible to cause alienation by introducing measures that they do not like or know how to use. The need to create a sense of 'ownership' cannot be underestimated: by giving road users the feeling they have had an input into scheme, they will value it more.

Once agreement on the strategy has been achieved, the project goes through detailed planning and design stages; during these phases, careful consideration must again be given to the public education and publicity required, along with any enforcement measures by the traffic police. Consultation and participation by the public is again particularly important prior to and during the implementation phase. Once the measures are in use, it is considered essential to monitor and evaluate the effect of these measures upon the safety record of the area and also to see if they do have a positive impact on, for example, the movement and speed of traffic.

1.7 Focussing on the urban poor

It has already been noted that the DFID programme has an underlying poverty and livelihoods focus. There are three principle stages for incorporating poverty into urban safety management at the outset of any proposed programme, and these are:

- Incorporating appropriate methods for identification and prioritisation of the poor.
- Identification of areas on the network where the road safety of the poor is being compromised.
- Forecasting potential impact of road safety interventions on the poor.

The special problems of the urban poor are one of the background issues considered in Chapter 2, and incorporating their needs into the USM programme will be discussed at each relevant stage of the process.

1.8 Overview to the Guidelines

Chapter 2 Background Concepts and Issues considers a number of issues and approaches to transport infrastructure problems that have contributed to the thinking behind the USM process recommended in this manual. The seven remaining technical chapters will cover all the steps necessary to implement USM methods in developing countries.

Chapter 3 Problem Analysis: Assessment of Network Safety discusses the process of evaluating network safety. It considers the methods of obtaining accident data, bearing in mind the particular difficulties of working in many developing

countries where such information is not necessarily collected and stored in an effective or reliable way. A number of techniques for analysing the data are described. The chapter also considers the traffic conflict technique as a way of providing safety-related information.

Chapter 4 Problem Analysis: Collecting Survey Data covers the collection and analysis of engineering, traffic and other road user behavioural data. It first discusses how to collect data that will be valuable and when analysed will highlight areas that require the implementation of safety measures using the USM process. Different data collection techniques are discussed such as traffic flows, geometric data, the speed of traffic etc, and advises on the way to analyse such data to provide information about the traffic levels and road user behaviour which need to be taken into account when seeking out practical solutions to reduce road collisions.

When a local area safety scheme is implemented, there will always be local residents and road users who are inconvenienced by the changes. This highlights the importance of consultation with road users and stakeholders to get their co-operation and acceptance in order for the project to be successful. **Chapter 5 Consultation** examines this role of consultation in the planning and implementation stage of an USM project, discussing who should be consulted and how to consult with them.

Once all the relevant data has been collected, and the local public and stakeholders' opinions obtained, it is important to analyse that information in order to consider implementing certain measures in certain areas. **Chapter 6 Decision Making for Solutions** discusses the process of analysing the available information, identifying areas of priority, developing strategies to tackle the problems found and then planning the countermeasures required to enhance safety and the feeling of safety.

Chapter 6 also discusses strategies for school education with an emphasis upon appropriate materials and 'self discovery' learning in a safe environment, including some direct roadside training; driver training, with particular concern about the need to reduce the high accident rates of novice drivers; the effective design of road safety publicity programmes; and the most effective strategies for traffic policing.

To assist in selecting and planning appropriate countermeasures, **Chapter 6** also presents a wide selection of the available engineering measures that could be implemented when applying USM. Three types are considered. Firstly, measures aimed at improving road user behaviour, which includes channelisation, the use of alerting devices and road signs, and speed-reducing measures such as speed humps and chicanes. The second type of measure focuses on the provision of facilities for road users. Pedestrian facilities such as footpaths and crossings are examined, along with the segregation of road users using barriers, cycle and motorcycle lanes etc. Examples of junction treatments include roundabouts and splitter islands. Ways in which illegal parking can be prevented are highlighted. General traffic management measures which also have a safety benefit, such as implementing one-way systems, are also considered. The third type of measure is aimed at minimising crash severity and creating a forgiving road environment so that when accidents do occur, they do not necessarily result in serious injury or death. The measures described include crash barriers, crash cushions and skid resistant surfaces.

The processes of developing the final designs and implementation are considered in **Chapter 7 Final Design and Implementation Stage**. Particular attention is drawn to the needs of 'safety conscious design' and safety auditing. Safety at the roadworks

during construction, consultation and publicity prior to opening and close on-site observations in the first few days after opening are among the issues discussed.

Chapter 8 Assessment: Monitoring and Evaluation provides information on to how to monitor and evaluate those USM techniques that are implemented and their effect on improving the traffic management and safety of the area. The evaluation of implemented measures involves the assessment of the function of the road network, and determining the performance relative to the intended function of a single road, or the network as a whole. Monitoring is essential in order to determine the level of success of an USM scheme. This involves repeating techniques used to collect data at the outset of the project in order to:

- Assess the effects of the scheme on accident occurrence,
- Assess the effects of the scheme on the distribution of traffic movements and speeds, identify unintended effects on traffic and accidents,
- Assess the effects of the scheme on the local environment, and finally,
- Determine the public response to the scheme.

Chapter 9 summarises the main points raised throughout the manual, particularly the benefits of implementing USM techniques in virtually all urban areas where safety problems abound.

Appendix A discusses definitions of urban poverty; and

Appendix B gives brief descriptions of the main statistical tests that can be applied in diagnosing problems or evaluating effectiveness.

1.9 Case studies

1.9.1 Why were these case studies chosen?

The two case studies in annexes 1 & 2 were carried out as part of the development programme for these guidelines. Both studies help to illustrate how USM methods can be implemented in different sized urban areas in different regions of the developing world. The location and extent of the two study areas were selected to fit the strategy intended. The two cities were:

- Cirebon, Indonesia to illustrate the Whole Urban Area Safety Scheme (WUASS) approach and;
- Bangalore, India to illustrate a Local Area Safety Scheme (LASS) strategy (see section 1.3).

Bangalore is a rapidly developing city having become the leading IT centre in India. As a consequence, it is experiencing a rapid increase in population and number of vehicles on its roads; it is also experiencing a widening gap between the rich and poor communities. With this rapidly increasing level of traffic, and the inevitable consequence of a worsening road safety record, the city urgently needs to control traffic movement and **manage road safety efficiently**. There has been a long term concern about the growth in road accidents in the city, and it has been running TRL's MAAP (Microcomputer Accident Analysis Package) accident data system since 1991, another reason the city was chosen. There are already 1,250,000 vehicles in Bangalore serving a population of nearly 6 million inhabitants. Official figures (NIMHANS, 1999) indicate that in 1998 nearly 14,000 people were injured and 800 people killed in road accidents. However, it is estimated that 40-50% of injuries and

5-10% of deaths went unreported to the police, suggesting a major under-reporting problem within the city, and emphasising its poor road safety record.

With its world class IT industry, Bangalore has become a very forward looking city with a vision of emulating Singapore in terms of safety, cleanliness etc. Among other things, this has increased their desire to enhance the urban environment by improving traffic movement and the safety of road users. There was considered to be a good prospect that measures suggested by this USM study would be implemented by local agencies.

Only a Local Area Scheme approach (section 1.3) was attempted in Bangalore because of the size and complexity of the city, and the time and resources available. This meant that the consultation process tended to focus on local rather than city-wide stakeholders.

Cirebon, Indonesia, on the other hand was chosen for the second case study as, being a smaller city, it offered a greater opportunity to show how USM techniques could be implemented on a city-wide level to improve the general traffic management throughout the city. Thus, it illustrated the Whole Urban Area Safety Scheme approach to USM (see section 1.3), and the much wider consultation process required involving the full range of stakeholders concerned with the transport and planning development of the city.

As with Bangalore, Cirebon has seen its population increase dramatically in recent years as people migrate to the urban area for employment. The growth of traffic has led to an inevitable growth in accidents and the fact that it had implemented the MAAP accident data system in 1998 was again among the reasons the city was chosen. Cirebon is a major port in Indonesia with a thriving petrochemical industry, attracting workers, and also an increasing the amount of traffic transporting goods to and from the port. Cirebon aims to be one of the major ports in Indonesia and this will increase the need to control the movement of the port traffic to help reduce congestion and the already high incidence of accidents. There was a good prospect of implementing the measures suggested by this study through a World Bank project, and therefore, it was hoped the city would become a good example for other developing cities.

1.9.2 What do the case studies illustrate that other cities could follow?

The two case studies were chosen in two different regions of the developing world so that they could address a diverse range of safety issues that are faced throughout the most populous areas of the developing world. Bangalore and Cirebon have some similar safety concerns but also many contrasting issues, providing excellent examples from which the authorities in many urban areas in developing countries could learn.

The case study of Bangalore is based on two suburbs within the city, Malleswaram and Seshadripuram. The area of Malleswaram consists of four main roads and several minor access roads in a grid pattern, which link in to the surrounding transport system. One of these roads, 5th Cross, has fast flowing traffic along with high pedestrian levels due to a hospital, schools, a police station and commercial properties situated along it. Of the remaining three roads, one is a one-way street and another is primarily used as an access road for residential properties. Seshadripuram is a nearby area chosen as a control area that has similar accident patterns and drivers behave in a similar way as in Malleswaram. There are also similarities in the land use around the main roads with schools in the area and

commercial and residential properties providing a large number of pedestrians. Choosing these smaller areas has provided examples of the types of problems that may be encountered, and how USM strategies and objectives might be translated into local area safety schemes.

The Cirebon case study illustrates how to formulate a safety strategy for the urban area as a whole and demonstrates the type of information needed to review USM at the strategic level. Before the team arrived, a bypass had been constructed with funding from the World Bank, and a number of road safety measures had been carried out, but the project had not considered the centre of Cirebon. It was hoped that the World Bank countermeasure programme could be extended to the study area in this USM project but, in the event, these were solely focussed on the bypass.

1.9.3 Limitations

Inevitably, the two case studies cannot possibly address every issue faced in cities in developing countries. Therefore, there may be problems other cities face that the case studies have not encompassed. However, the trial applications have addressed a diverse range of issues that are found in many developing cities from which similar town and city authorities can learn a great deal.

2 BACKGROUND CONCEPTS AND ISSUES

As discussed in Section 1.1, Urban Safety Management attempts to bring together a variety of disciplines and views, including Traffic and Highway Engineering, Urban Planning, Health, Education and Enforcement. In this chapter, we discuss various principles and issues that will have a strong bearing on the approach taken in analysing the problems in a USM project and the framework for developing solutions. This will cover engineering, road user behaviour and the concerns of the urban poor.

2.1 Engineering and Planning

2.1.1 Road hierarchy

One of the fundamental processes of USM is defining and establishing the engineering road hierarchy. The aim of the hierarchy is to distinguish the role each road plays in the movement of vehicles, so traffic is concentrated onto roads appropriate to its journey purpose. Improvement proposals, maintenance allocations and environmental standards all relate to the different hierarchy levels so that a road's character is developed to best suit the function that it has to fulfil. When fully developed, the road hierarchy matches the road environment such that roads can be categorised (see IHT, 1991) into the following five tiers (see Figure 2-1):

Primary Distributors: These should be used by fast moving, long distance traffic, with no pedestrians or frontage access to residential, commercial or industrial properties. These are suitable to carry all forms of motorised transport. The standard of roads that will fit this category and the volumes of traffic carried are likely to vary considerably. Where the standard is low, there may well be much scope for modifying, say, the points where traffic joins or leaves these roads within a safety improvement scheme.

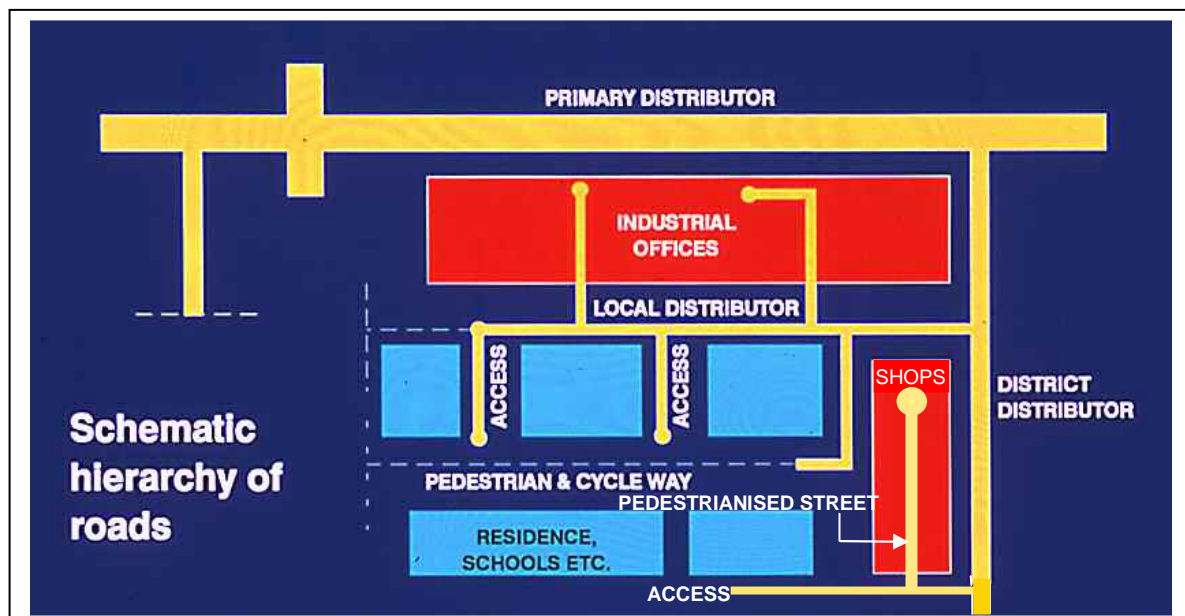

Figure 2-1: Schematic hierarchy of urban roads

District Distributors: These are intended for medium distance traffic, linking the urban centre to the main industrial areas and the primary distributors. There is minimum pedestrian activity, but positive measures are taken for pedestrian safety. In some towns, the same major roads will serve both primary and district distributor

functions, and also have frontages of homes, shops and businesses along them. In deciding the functions of a road it is important to take account of the requirement of public transport users and the way in which vehicle size, bus routes and priority can influence the hierarchy.

Local Distributors: These are where vehicle journeys near their end. Predominantly found as the main roads running through residential areas, providing a link between access roads and the district distributors. There are controlled pedestrian movements using pedestrian crossings to assist pedestrians to cross roads. They will often have frontage access to homes and other buildings and should not be designed straight but to be gently curving so as not to encourage high speeds.

Access Roads: These are for slow moving vehicles, as they are regularly used by pedestrians who cross the road where it suits them. They provide vehicle access to individual homes and businesses. They must, of course, also be designed to cater for those vehicles making regular collections and deliveries, and for emergency vehicles.

Pedestrian Streets: These are specifically for pedestrians only, often with commercial properties lining the street, and are frequently main shopping (high) streets that have been pedestrianised. They allow pedestrians to cross the street at random with no potential danger from vehicles. They may also allow cyclists usage. Some may be regarded as partial pedestrian streets since they may allow public transport vehicles including taxis, or allow access for motor vehicles at restricted times.

Each road type should link with roads of the same class type or one immediately above or below it in the hierarchy. This will give the driver a clear impression of changes in the road type and therefore an indication of the safe speed at which to travel. It will also help to ensure that faster vehicles do not travel directly from a primary distributor to an access road, causing potential safety concerns for pedestrians, and other non-motorised road users.

However, roads in developing countries can have a far different traffic mix than in developed countries and a definitive engineering road hierarchy can be more difficult to determine. Thus many roads can carry out a range of functions, including being a district distributor and transporting traffic throughout the city, to being an access road with houses and local amenities situated along it. This causes conflicts when attempting to develop USM techniques, and an adaptable approach may need to be sought.

Instead of an engineering based road hierarchy, **a function-based evaluation** might be more appropriate in some developing countries, with land use being a key indicator of the road function and identifying whether this accords with the designated traffic function. This different approach would often give priority to pedestrians and those using the services situated along these roads as opposed to concentrating on vehicle needs and justifying safety measures to suit them.

In a number of countries, continuous segregated routes have been developed linking areas of a town or city which can also be considered part of the road hierarchy - and have considerable potential for developing countries. These include:

Pedestrian routes: These routes can include roadside footways, shared areas with other vehicles, footpaths or special pathways designed for shared pedestrian and cyclist use.

Cycle routes: These again can include shared paths with pedestrians, separate cycle lanes on busy roads and separate cycle tracks.

Motorcycle lanes: These are purely dedicated to motorcycles in countries such as Malaysia and Indonesia which have very high usage of motorcycles.

2.1.2 Safety Conscious Design

Increasingly, highway engineers – especially those in countries that have adopted highway safety auditing - are learning to think in depth about the safety implications of their schemes, from right at the concept stage, through the design and construction stages to the opening of the scheme. They have learnt to appreciate fully that they can save lives by their designs and decisions, and that safety does not necessarily cost extra money. This approach has been termed 'Safety Conscious Design':

Principles of Safety Conscious Design	
• Design for all road users	• Meet drivers expectancies – if not, alert the driver physically or with heavy signing
• Segregate wherever possible	• Prevent drivers from behaving badly
• Safety in details of design – 'Forgiving Design'	• Encourage appropriate speeds
• Consistency of design	• Be aware of human limitations –they are always making errors

These principles underlie the advice given in the TRL/DFID publication "Towards Safer Roads in Developing Countries" (TRL et al, 1991) available from TRL.

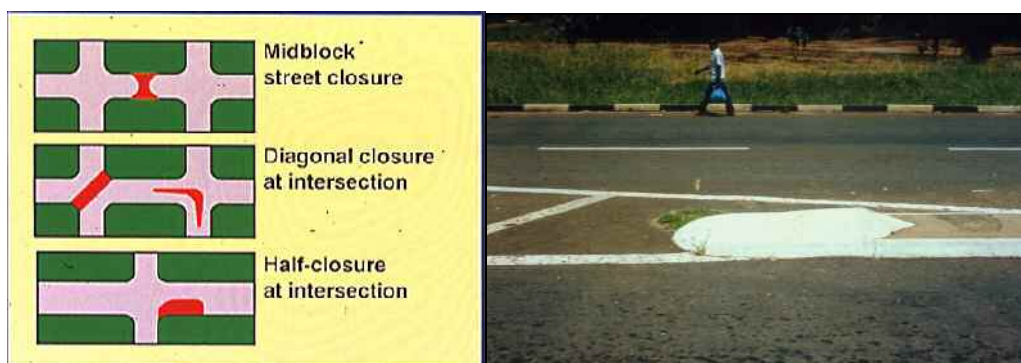

Figure 2-2: From route planning to the smallest details of design, the highway designer can save lives



Figure 2-3: Low cost highway engineering countermeasures can be highly cost-effective

2.2 Road User Behaviour, Education and Enforcement

This section is concerned with road user behaviour as observed in an urban environment, and how education and enforcement policies might influence that behaviour to reduce the occurrence of road accidents.

2.2.1 Factors affecting road user behaviour

In order to deal with problems of road user behaviour at a local level, it is necessary to have some understanding of what leads drivers and pedestrians to behave in the way they do. This section gives a brief discussion of current thinking about this.

Poor road user behaviour, and primarily poor driver behaviour, is a factor in the vast majority of accidents. As consequence a huge amount of research had been conducted around the world on what factors influence driver behaviour and how it can be improved. The emphasis has been on those behaviours that result in accidents, such as speeding, close following and (in some countries) drinking and driving. In spite of all this research there is no simple and freely available recipe for improving behaviour and safety. There are a variety of reasons why improving driver behaviour - and safety - is not easy. These include:

Road accidents are relatively infrequent events, often caused by a random occurrence of two (or three) contributing factors. This means that it is difficult to discover relationships or 'model' such events.

Road safety and driver behaviour is influenced by other extraneous factors such as levels of employment, economic progress (e.g. number of vehicles), and changes in population demographics.

Changes in legislation (e.g. making seat-belt wearing compulsory) can also have sizeable effects on safety even though behaviour (apart from wearing a seat-belt and, as a result, having less severe injuries if involved in an accident) can take long time periods to change.

Theories about accidents such as 'accident migration' (where black-spot treatments 'move' accidents to elsewhere on the road system) and 'risk compensation' (where drivers compensate for safety improvements by driving more dangerously to maintain the level of accepted risk) are still controversial and cloud the safety arena - since they (incorrectly) claim that road safety improvements cannot be achieved.

Individual drivers are not constant factors. They may simply be in a hurry, may be tired, be angry (and aggressive) or even driving under the influence of drugs or alcohol. Similarly, factors such as weather and national holidays can influence behaviour and accident numbers.

Because of these complexities, promoting road safety requires a multi-factor approach that uses a variety of measures such as enforcement and public education as well as engineering. A number of behavioural issues deserve special mention and some of these are considered below, including the more general issues of 'causes' and 'methods for improvements' since these can span more than a single sector.

2.2.2 Identifying the causes of behaviour

As noted, driver behaviour is a complex issue - and the perspective taken by researchers is very much influenced by their research backgrounds. Sociologists, psychologists and, indeed, engineers – and many other specialists - start with a different viewpoint and vocabulary and the integration of their different ideas is often difficult to resolve.

Also, one critical issue that is often forgotten is as stated above, that a particular driver does not always behave in the same way. These temporary states, for example, being late for an important appointment, being angry (after an argument with a boss), or simply being tired will affect the way a person drives as will more permanent personal traits such as personality (eg aggressiveness, criminality, etc). Similarly, driving behaviour is influenced by whether the driver is alone, with a member of his peer group or his parents. The vehicle driven (and economic status) is also important.

From a safety perspective it is necessary to consider all road users and not just the driver. In vehicle-pedestrian accidents, the driver or the pedestrian, or both, may contribute. Also, poorly designed roads and badly maintained vehicles may contribute to 'behavioural' accidents.

A common belief in traffic psychology is that "a man drives as he lives". In other words his driving is influenced by economic, social and cultural issues. Also important are his perceptions of the traffic system (e.g. the likelihood of being punished if caught speeding) and of himself (e.g. how skilful a driver he thinks he is). A driver also adapts to the driving environment he is in and behaves in a similar way to other drivers. This adaptation process happens remarkably quickly so that a driver in a new country (or city) will quickly drive in a similar way to the others around him and not as he has been driving (often for many years) in his home territory.

The planning and the design of the road network plays a major part in driver behaviour, e.g. many drivers who are presented with wide roads, tend to speed. Or, for example, if the layout of an opening between a main road and a service opening is intended to prevent specific movements, some drivers ignore the signs and perform dangerous manoeuvres to save time and avoid long detours.

No research study is ever able to take account of all these various factors. Furthermore, studies using in-car observation may not reflect a driver's normal behaviour. Many 'behavioural' studies interested in accident liability deal with large numbers (i.e. driving populations) and succeed in revealing the importance of age (or experience), economic status and (in some countries) gender.

However, this complexity is tempered by the fact that safety legislation and traffic regulations can only deal with a limited number of issues. For example, while the licensing age can be changed, driving experience cannot be legislated for in any simple way, nor is it easy to introduce legislation restricting novice drivers to low power cars, or not driving in the evening with their peers, circumstances when many accidents are known to occur.

2.2.3 Social and Cultural issues

Social, psychological, economic and cultural factors all play a role in how a society (and individuals) behave. Similarly, human factors such as age, driving experience and gender have all been found to influence behaviour and safety.

The issue is how such knowledge (or lack of knowledge) can be used to prevent accidents. In most countries around the world, young drivers are involved in more accidents than older drivers. In part this is caused by younger drivers having less driving experience, but it is also caused by younger people having different attitudes and lifestyles to older drivers who have more settled lives and more responsibilities. The 'youth' problem is especially relevant in a number of developing countries because they have a relatively young population and the tendency to have larger families than in many other countries will mean that the average age of the driving population will continue to fall.

Another issue directly relevant to some countries is the role of religion. This can have a very powerful influence on people's lives and the way they behave - both as individuals and as members of society. In these circumstances, this can provide a powerful opportunity to educate and influence behaviours of all types - including driving. Ideally a culture of safety needs to be developed in which drivers are more considerate to others and less impatient.

Generally, such changes that are required cannot be brought about quickly, and may require considerable investment and political will to succeed.

2.2.4 Changing behaviour through training and education

Behavioural psychological theory suggests that people modify their behaviour as a result of receiving rewards or punishments. In this context penalties (e.g. for speeding) can be seen as punishments while lower insurance costs can represent rewards; although the strength of such inducements can depend considerably on the individuals concerned.

However, more cognitive psychologists think that new information, experiences or perceptions can bring about a change of attitude and/or behaviour - which is why education and publicity (which can both provide new information) and enforcement activity can be used to promote safety.

There is no single (or simple) way of changing behaviour. What is needed is a multi-factor (or sector) approach based on the different sectors.

Within this framework it is important that the road users in a local area are made aware of the size of the problem, are informed about the general social and economic costs of road accidents and (importantly) persuaded that it is important for them and their families to take personal 'ownership' and responsibility for improving the situation.

In addition to the 3 'Es' of safety (education, engineering and enforcement) there will also be a role for more general traffic and transportation schemes - such as improved public transport, 'intelligent' traffic systems, and introducing some of the traffic management schemes to prevent bad behaviour due to the road layout.

To be safe in traffic, road users need to know how to behave properly and how traffic rules and regulations apply to them. It is also important that they appreciate and understand the risks involved with roads and traffic. This 'education' should start at an early age, for example in school, but needs to continue throughout a person's life, since older people have particular problems that can be reduced by providing them with appropriate guidance.

Traffic safety education can be considered as being made up of three separate elements:

- Road safety education (RSE) - for children in schools
- Driver training and testing - of new drivers, and
- General mass media publicity programmes - targeting the general public.

It should be noted we are including driver 'testing' within this education sector even though it does not involve an education element. This is because it is closely aligned with the education received by novice drivers - during driver training - and in general the testing regime determines the quality and extent of the training undertaken by drivers in order to pass the driving test.

2.2.5 Changing behaviour through Traffic Law and Enforcement

It is often the case that unsafe behaviour (such as speeding and red-light running) results in immediate reward (psychological reinforcement), in that journey time is reduced and 'points' are scored against other drivers – who can be viewed as rivals competing for road space. The use of enforcement is required to cause breaking rules to result in punishment – not reward.

Driver behaviour can be strongly influenced by having **effective** penalties in terms of both size and the behaviours being targeted. Rather than having a single penalty, it may be better to fine a driver according to his ability to pay (i.e. richer drivers pay more) whilst to promote safety it may be better to focus on injury causing behaviours such as speeding and red-light running rather than static offences such as illegal parking.

Having an effective penalty points system in place can also be important, since this provides a continuous and long-term mechanism that cannot be ignored by those individuals who are happy to simply pay (or avoid paying) for committing regular offences.

However it is vital to recognise that the role of enforcement and penalties is to 'persuade' the many rather than punish the few. This means that enforcement should be high profile and well publicised - and certainly not used as a way of collecting revenue. Speed enforcement will have worked when no drivers are being caught and no penalties issued and therefore a driver's perception is more important than his experience.

2.3 Focussing on the urban poor

By its nature, Urban Safety Management will tend to reveal the problems of the vulnerable road users, especially pedestrians and cyclists, and to a certain degree

these will be from the poorest in the community. However, it is the policy of DFID and other aid agencies to be more sharply focussed on identifying and tackling the problems of the poor. This section gives special consideration to the problems of transport for the urban poor. A framework for defining the urban poor is discussed in Appendix A.

In 1998 the share of population living on less than US\$1 a day in developing and transition economies was 24%, with 70% of the poor population living in South Asia and Sub-Saharan Africa (World Bank, 2000). Currently 1.2 billion people live in abject poverty (DFID, 2000). There are no accurate figures for the proportion of the world's population living in absolute poverty in urban areas, yet estimates vary, for instance the World Bank estimated that 330 million of the 'poorest poor' were living in urban areas in 1988 (UNCHS, 1996). Definitions of poverty are imprecise, but can be described as deprivation in well-being. The poor are particularly susceptible to vulnerability to external shocks and stresses, which prevent them from taking advantage of higher-risk, higher-return opportunities. Road traffic accidents (RTA) are a case in point, whereby fatalities or injuries caused by an RTA have devastating impacts for households directly involved. For instance, the cost of healthcare for an RTA casualty may cause other members of the household to sacrifice their income, education, and material assets for payment, not to mention the time required for nursing the invalid. In addition, there are associated costs of death in a household, especially if the deceased is the major 'breadwinner', in which case the household income will substantially decrease.

Jacobs et al (2000) estimated that nearly 1 million deaths and up to 34 million injuries occur on roads world-wide each year costing around US\$100 billion. The most prominent victims of road traffic accidents are the poor, who are often neglected from formal road safety education schemes, which are usually carried out under the national school curriculum. The urban poor often live in informal settlements which are both unplanned and inaccessible by public transport networks, hence proliferating overcrowding and travel by foot on the road. It is well documented that people travel farther as income rises, but they do not necessarily travel for longer periods of time. This is particularly true of vehicle owners whose trip distance is often longer, with a shorter trip duration than the poor who are only in a financial position to access public or non-motorised means of transport.

Urbanisation is taking place at an alarmingly rapid pace. Urban populations account for 40% of developing country populations, which is expected to rise to 56% by 2030 (WBCSD, 2001), fuelling the growth in demand for mobility. The majority of the 'new' urban poor who are migrating to cities reside in informal settlements in the outer periphery of metropolitan regions, sometimes 20-30km from the central business district where informal employment can be found. There exists in developing cities a complex trade-off between residential location, travel distance and travel mode with many low income households locating themselves remotely in order to inhabit affordable living space, but with consequential high travel costs and long travel times. For instance the average daily commuting time for poor income groups in Rio de Janeiro exceeds three hours (World Bank, 2001b). It is not surprising then that transport accounts for between 8-16% of household expenditure in African and other Southern cities.

In terms of urban road safety, the poor are a high risk category group because they live in unregulated, highly congested settlements which often spill over onto or nearby major road and rail networks. Surveys in East Africa (Howe and Bryceson, 2000) found that in general, the expense of public transport and lack of safe

alternatives, for instance cycling, in developing country cities determines that walking remains the only viable travel option for low income populations. Pedestrians are often neglected from the planning of urban road networks, which are designed for motor vehicles only, causing pedestrians to walk in the carriageway, or on unprotected road shoulders, resulting in 'human traffic congestion' and increased exposure to traffic hazards.

Similarly, in her paper on pedestrian infrastructure in Delhi, Tiwari (2001) describes the prevalence of 'captive pedestrians' and public transport users in Asian cities. For the majority of the urban poor, even subsidised public bus services and bicycles are financially prohibitive, and because of the inherent lack of safe infrastructure, pedestrian and public transport trips as a percentage of total journeys have declined over recent years. Yet, walking is often the only option for commuting to work by low income groups, hence a significant proportion of the population falls into the category of 'captive pedestrians'. In Delhi, pedestrians, cyclists and two-wheeled motor vehicles constitute 75% of total road traffic fatalities (Tiwari, 1993). Here, problems arise from the use of road space by different motorised and non-motorised road users, pedestrians being the most vulnerable to accidents and associated fatalities.

Transport nodal points in high-density areas, including bus terminals, tend to be poorly planned and are therefore RTA (Road Traffic Accident) hotspots because of the density of people in the road at any one time. Urban RTAs involve a high proportion of buses and commercial vehicles, and occur predominately on links rather than at junctions, highlighting the dangers of the current emphasis on capacity expansion often at the expense of vulnerable road users. A study of road traffic safety management issues in metropolitan cities in India (Mittal and Sarin, 2000) found that the most vulnerable group involved in RTAs is of non-motorised users, especially amongst the most productive age group in the dark hours of early morning and evening caused by faulty road user behaviour (both pedestrian and vehicular road users).

3 PROBLEM ANALYSIS: ASSESSMENT OF NETWORK SAFETY

This section describes the first major aspect of the Problem Analysis phase of USM - network safety assessment. Methods available are described for analysing the available accident and other sources of data to assess the safety of the network as it is currently operating. In Chapter 4, the second major aspect of Problem Analysis is discussed: the collection of survey data.

3.1 Objectives

The primary objective of a network safety assessment is to establish the characteristics of the road safety problems of the area under study, be it city-wide or a local area. The following are the major features that need to be established:

- The location of accidents, identifying any single site clusters, streets or areas of higher risk
- The road users involved in the accidents
- Locations of the most severe accidents
- The collision types of accidents
- The distribution of accidents by time of day and day of week, and any significant seasonal variations
- The vehicle types involved
- The ages of the casualties. If schoolchildren, whether they were on the way to school
- Alcohol involvement
- Any patterns to the accidents, either within a site or street, or for similar collision types over an area
- Any location where road users feel particularly unsafe, but where few accidents are reported

The characteristics of the accidents will often suggest the engineering measures which will be most likely to be effective in reducing the road safety problems. In assessing the network safety, it should be born in mind that USM is most frequently concerned with area rather than treating single site problems.

3.2 Sources of information

The main source of information should normally be the police or engineering department's road accident data system. There have been major improvements in accident recording and analysis in many cities in developing countries over the past 20 years, particularly with the introduction of low-cost computer systems such as TRL's Microcomputer Accident Analysis Package (MAAP). However, in many cities, these systems are not developed enough to answer the questions above, or for various reasons, there may be massive under-recording of accidents. Under-reporting may affect different accident types differentially. For example, in the UK many accidents involving injury to cyclists and pedestrians are not reported to the police as the victims are frequently rushed straight to hospital. One of the common limitations is the poor recording of accident locations. For various reasons, It may therefore be necessary to supplement the analysis of accident data with other sources of information:

- Police ledger entries
- Local traffic police and traffic engineering knowledge of hazardous sites
- Interviews with a wide range of local stakeholders
- Interviews with local road users
- Conflict studies
- Hospital and ambulance records

3.2.1 Police ledger entries

A common practice of police forces is to record the occurrence of each road accident in a ledger, either in one just for road accidents or in the general ledger of all reported incidents, including road accidents. This is often a legal requirement where the information is used in court cases or for insurance purposes. Ledger records of road accidents normally consist of a “plain language description” of the accident occurrence. Ledger entries tend to provide less clear information for road safety investigation, since the information collected can be both variable and minimal and may concentrate on details less relevant to accident analysis such as the addresses of those involved. Precise accident location information suitable for safety studies is unlikely to be recorded.

Despite these limitations, these ledger entries can be used to build up information about particular road locations directly in the absence of an appropriately catalogued filing system or their information can be transferred to a structured accident database system which will tend to make the information easier to analyse.

3.2.2 Local knowledge of hazardous locations

The local traffic police will inevitably build up a good picture of local road safety problems from attending accident scenes in their daily work. Similarly, the local traffic engineers will often be called to accident sites, either to supervise the replacement of street furniture that has been damaged, or to discuss with the police or others solutions to problems. This experienced knowledge can be invaluable in assessing network safety, but a note of caution must be made. It has been found that this experienced knowledge can also sometimes be misleading due to the officers only experiencing a part of the network or particular times of day or week, and that computer analyses of accidents can point to a different priority of problems. Despite this caveat, the analysis of such experienced knowledge should be an essential step in the USM process.

3.2.3 Surveys of stakeholders and local road users

This is a fundamental phase in the USM process and is described detail in Chapter 3.

3.2.4 Conflict studies

This is a process whereby observers at a site assess near-collisions by their severity and type, usually over a period of hours. Research in Europe (Asmussen, 1984) has shown for experienced observers fairly good correspondence between severe conflicts and accidents. This technique is normally only necessary when analyses of accidents do not reveal clear cut patterns to the accidents. Conflict studies were experimented with in the Cirebon Case Study (Annexe 1).

3.2.5 Insurance, hospital and ambulance data

These have rarely been used in USM studies, but is another possible source of information if other sources are found to be inadequate. It must be noted however, that details of precise accident locations are unlikely to be present in hospital records.

3.3 Examples of analyses

In this section, examples are given of analyses both of accident data recorded by the police and other sources of information.

3.3.1 Location of accidents and perceived problems

There are two main methods for locating accidents in a computerised system:

1. A grid co-ordinate system, whereby location is indicated by eastings and northings from a local origin or a national origin. With the advent of digitised maps and Geographic Information Systems (GIS), this method is now predominant

2. A link-node-cell system, whereby each major junction or node is given a reference number, links are defined by the two nodes at either end of the link, and areas of minor roads bounded by links(cells) are given individual reference numbers. This labelling of major junctions and links can have advantages in analysing and prioritising sites.

Figure 3-1 shows an example of a simple plot of accident locations superimposed on a digitised map. The severity of accidents is differentiated by colour: Fatal – red; Hospitalised – blue; Injured not hospitalised – green; Damage only – lime green .

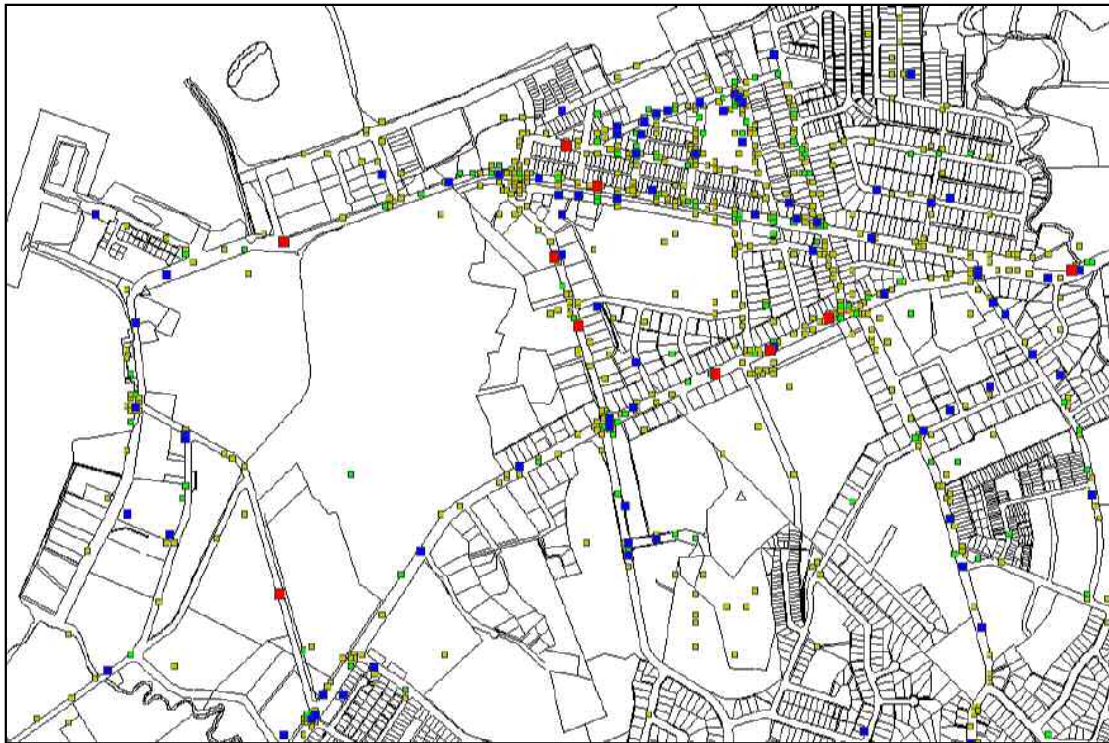

TRL MAAP for Windows/ Fiji data

Figure 3-1: Simple accident plot on digitised map showing different accident severities

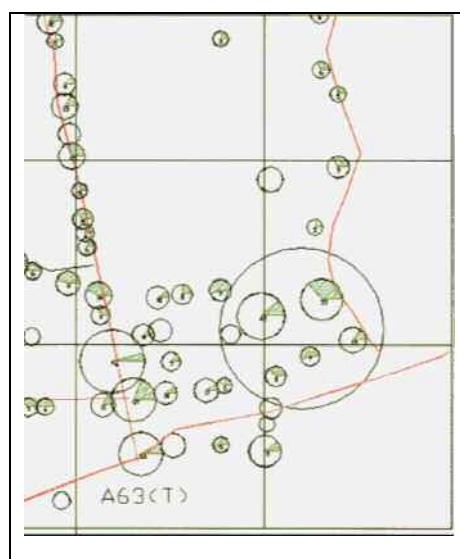

Key Systems/UK data

Figure 3-2: Circle size indicating the number of accidents at a single site with the proportion of pedestrian accidents shaded

With this simple display, if more than one accident has exactly the same grid co-ordinates, then only one of the accidents is displayed. To overcome this problem, various devices are used to display multiple accidents at a site. In Figure 3-2, larger rings are used to represent increasing numbers of accidents recorded with the same co-ordinates. The proportion of those accidents that are pedestrian is also indicated.

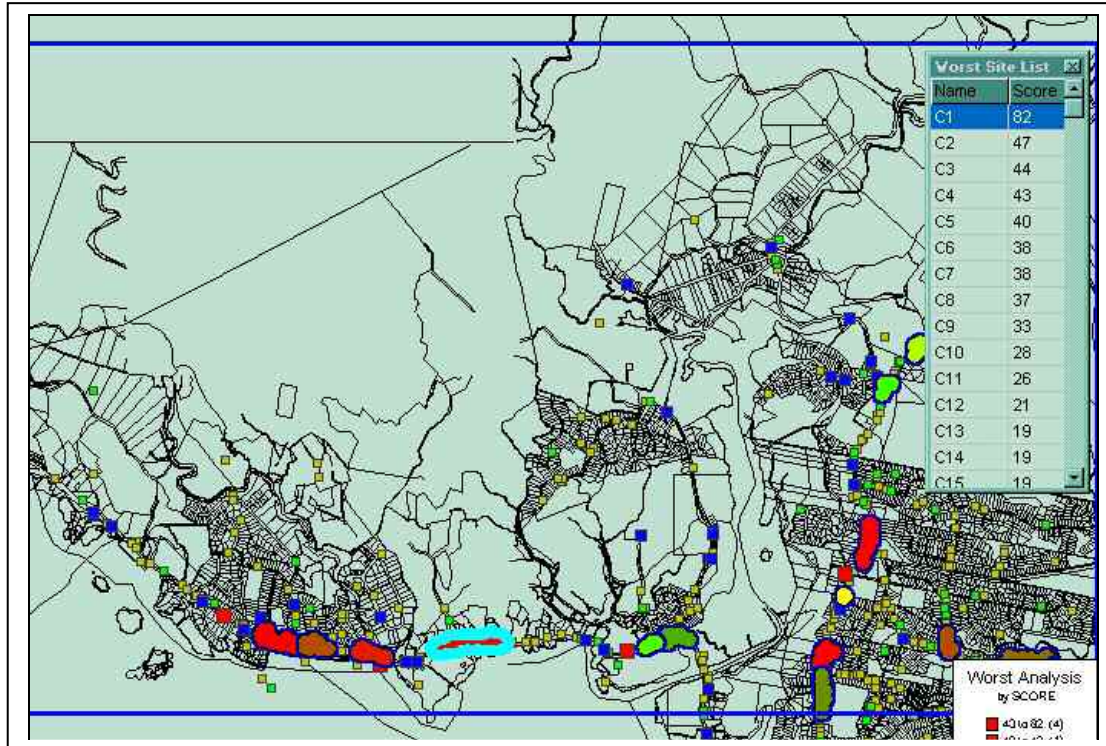

TRL MAAP for Windows/Fiji data

Figure 3-3: Identifying worst accident clusters

Computer software can also identify and order accident clusters (Figure 3-3). With this particular program, accident clusters have been defined as groups of accidents being within a set distance of the next accident; in this case, the distance 50m has been set by the user. This leads to variable shaped clusters as shown. They are ranked by scores derived by summing weightings assigned by the user to each accident within the cluster, in this case: Fatal – 10 points; Hospitalised – 5 points; Injured not hospitalised – 2 points; Damage only – 1 point.

Different methods of defining and displaying clusters are available. With the software used in Figure 3-4, a cluster is fixed in size and shape i.e circular and 50m radius. The computer then finds the sites with the worst accident history.

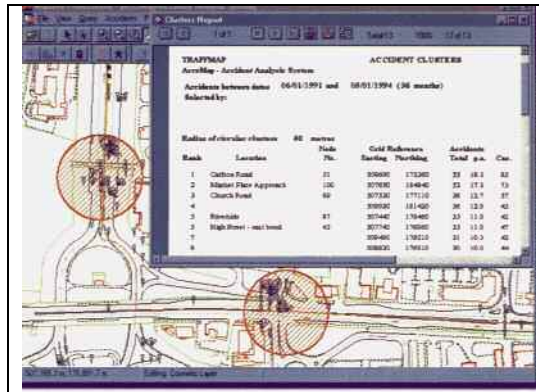

Key Systems (UK data)

Figure 3-4: Worst clusters defined as sites with the most number of accidents within 50m of the site

An alternative way of identifying the worst areas of a city is to divide it into a grid of equal areas cells and find the worst according to simple aggregation or by weighting. Figure 3-5 shows an example of such an analysis. This is possibly the most relevant type of analysis for the objectives of USM, which is not so concerned with single site clusters as areas of road accidents.

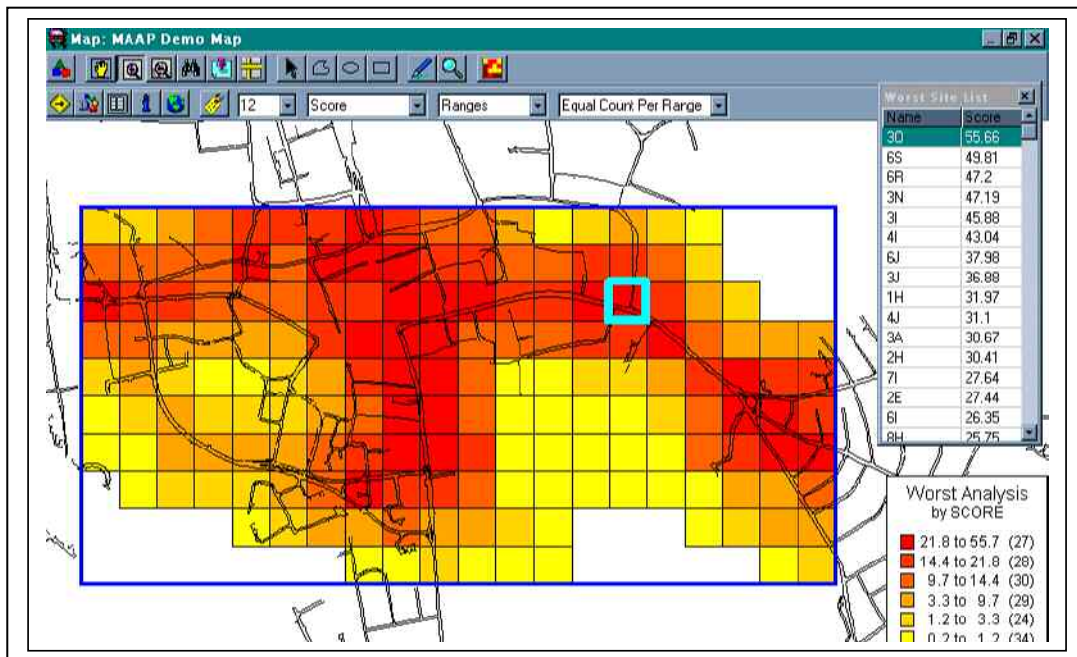

TRL MMAP for Windows/UK data

Figure 3-5: Identifying the worst areas of an urban region of Oxford, UK using data from Thames Valley Police

As discussed above, accident data is not the only source of information that should be considered in assessing the safety of a network. Figure 3-6 shows the locations of problems identified by traffic police and engineers in the Cirebon case study. They suggest a different pattern of priorities from the accident locations derived from the accident database.

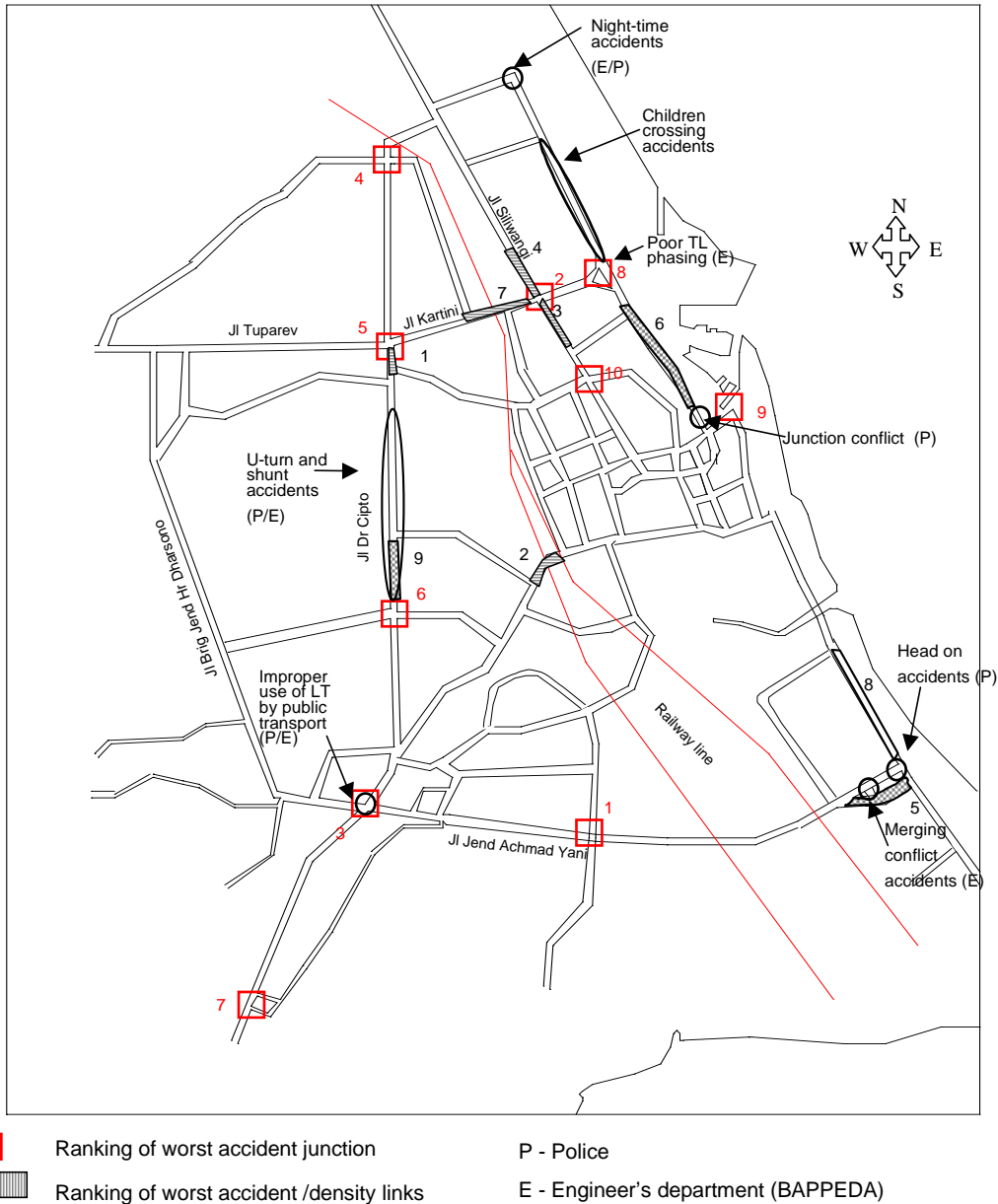

Figure 3-6: Cirebon case study area ranking of worst problem sites

3.3.2 Cross-tabulation analyses

Cross-tabulations are one of the most important tools available to the accident investigator, answering the basic What, Where, When, Who etc type of questions. However, because of the very large number of possible cross-tabulations (e.g. if there are 60 items in an accident record, then theoretically there could be 60 x 59 cross-tabulations), it is necessary to use experience and judgement to select the most useful for a particular study. Examples are presented here of those that have been found to be the most important.

Any unexpected results should lead to further analyses and detective work. At any stage, the investigator must be clear in his own mind which of three types of cross-tabulation is required to answer a particular question - that is, the entries in a cross-tabulation can be counting:

- accidents
- casualties; or
- vehicles.

Consider a single accident involving two vehicles and three casualties; it will add one to an accident table, three to a casualty table and two to a vehicle table. If the priority is to reduce casualties, then the investigator must be wary of 'Damage Only' accidents distorting the findings. It may be better in these circumstances to concentrate on casualties or restrict accidents to those involving injury only. On the other hand, this may reduce the sample size too much and conceal certain patterns. An example of this problem is that it is generally found that roundabouts (rotaries) reduce injury accidents but increase damage only accidents. An analysis of, say, Junction Type by Time of Day would reveal a very different picture if all accidents were counted rather than casualties or casualty accidents.

What were the predominant Collision Types?

Analysis of Collision Types is a basic cross-tabulation for most studies. The following casualty table analyses Collision Type by Casualty Injury Severity for an area of Suva, Fiji.

Table 3-1: Casualty table

Collision Type	Casualty Injury Severity			Total
	Fatal	Hospitalised	Injury	
Head On	1	10	16	27
Rear End	0	1	3	4
Right Angle	1	4	6	11
Side Swipe	0	3	4	7
Overtuned	0	0	1	1
Hit Object On Road	0	0	1	1
Hit Object Off Road	1	3	5	9
Hit Parked Vehicle	0	1	1	2
Hit Pedestrian	0	7	30	37
Other	0	1	11	12
Total	3	30	78	111

It is usually, but not always, helpful to display the results of a cross-tabulation graphically:

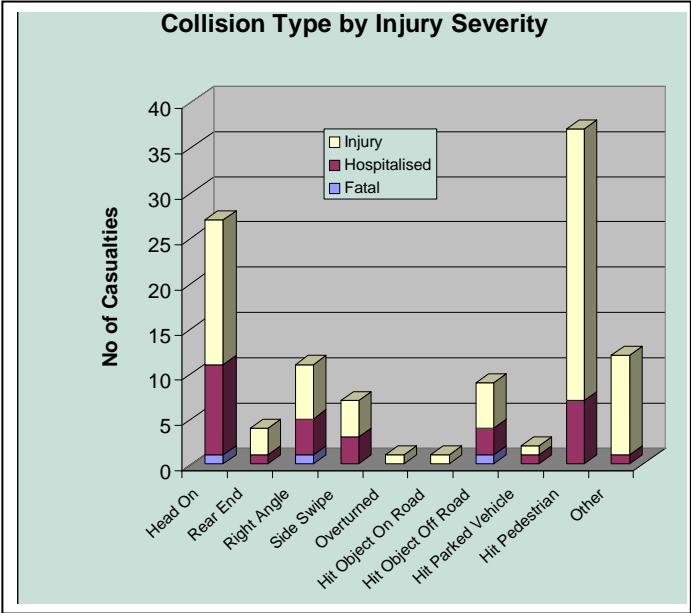

Figure 3-7: Example of cross tabulation

This analysis clearly shows two major collision types that lead to injuries: Hit Pedestrian and Head On.

What Road Users were involved?

The classes of road users injured are also of major concern. The following analysis from the Cirebon Case Study shows that motor cyclists, pedestrians and mini-bus passengers are the most numerous casualties. Furthermore, it can be seen that pedestrian casualties are predominantly occurring on links rather than at junctions.

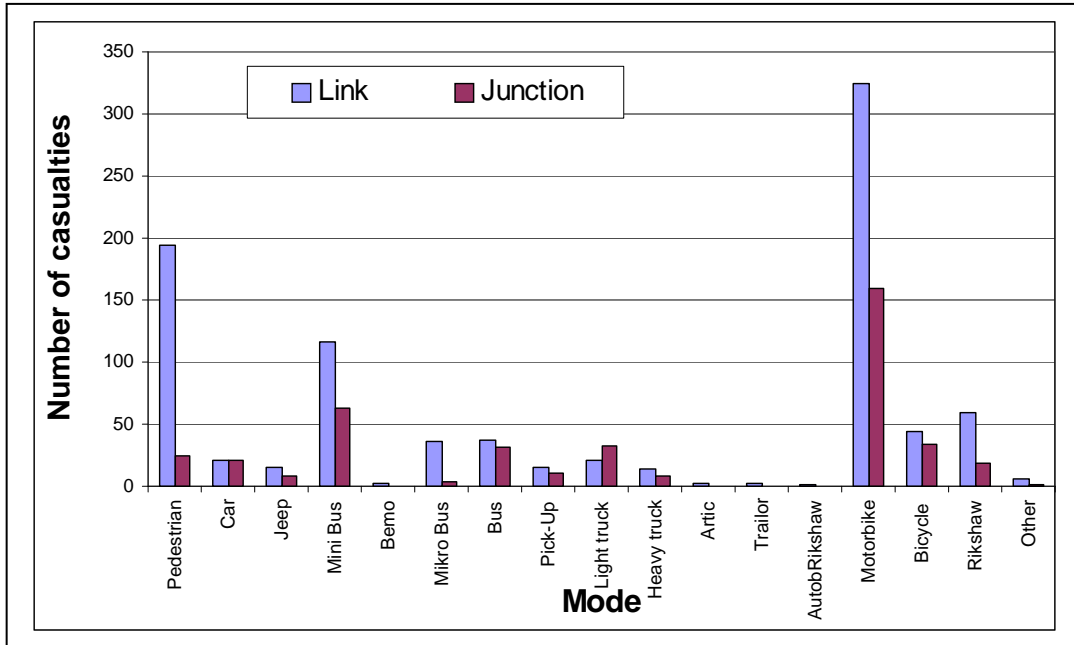

Figure 3-8: Example of casualty types bar-chart

When did the accidents occur?

Tabulating accident occurrence by Month, Day of Week, and Time of Day are again basic analyses. Figure 3-9 shows the distribution by time of day of injury accidents. The distribution

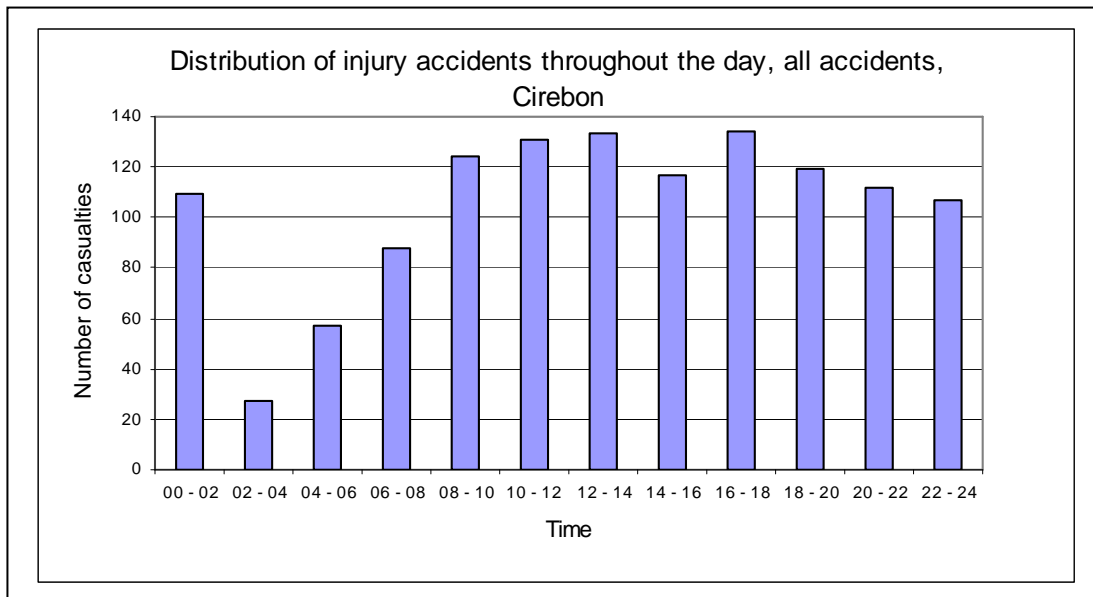

Figure 3-9: Example of distribution of injury accidents by time of day

is unusual in the high proportion of such accidents occurring between 10 pm and 2 am, and should lead to further investigation. It may merely reflect relatively high levels of traffic at these times of day, possibly associated with the port; or it might point to some other problem, such as street lighting or even possibly alcohol.

3.3.3 Stick diagrams

One of the main purposes of accident investigation or an in-depth assessment of network safety is to find patterns in groups of accidents, whether they are at a single site or spread over an area. A technique developed in the UK by accident investigators in the 1960's called 'Stick Diagram Analysis' (or 'Factor Analysis') has now become a basic tool in this process. This technique offers the user the facility to view groups of accidents whereby each accident record is represented by a column or 'Stick' of information. It is found that this helps the accident investigator visualise the factors in the accidents, and then by grouping (or shuffling) these 'Sticks' in particular ways (e.g by Time of Day), patterns in the accidents can often be discovered, hopefully identifying some underlying causes. The technique was first developed for analysing the factors in groups of accidents occurring at bad accident locations, but it can equally be used for examining any particular group of accidents. The example shown in Figure 3-10 shows part of a Stick Diagram Analysis with the accidents sorted by Day of Week (Hari). Further sub-grouping e.g. by Time of Day, can be carried out as required. The other factors shown in the stick can then be examined, to see if any patterns in the accidents are revealed.

Figure 3-11 illustrates the value of carrying out such an analysis. For the site analysed, Eastbound accidents all occurred in the wet and suggest a skid resistance problem in one part of the junction; on the other hand, the Westbound accidents all involved a driver saying he did not see the other vehicle ('vision obscured') and revealed a second problem caused by a tree on the footpath adjacent to the junction.

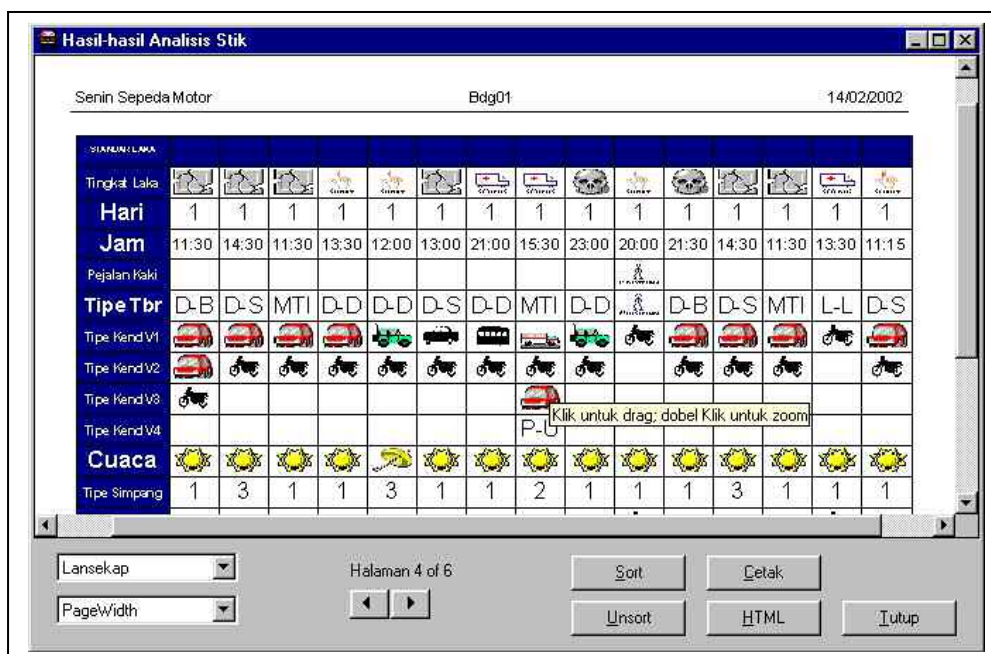

TRL MAAP: Indonesia data

Figure 3-10: Example of computer generated stick analysis

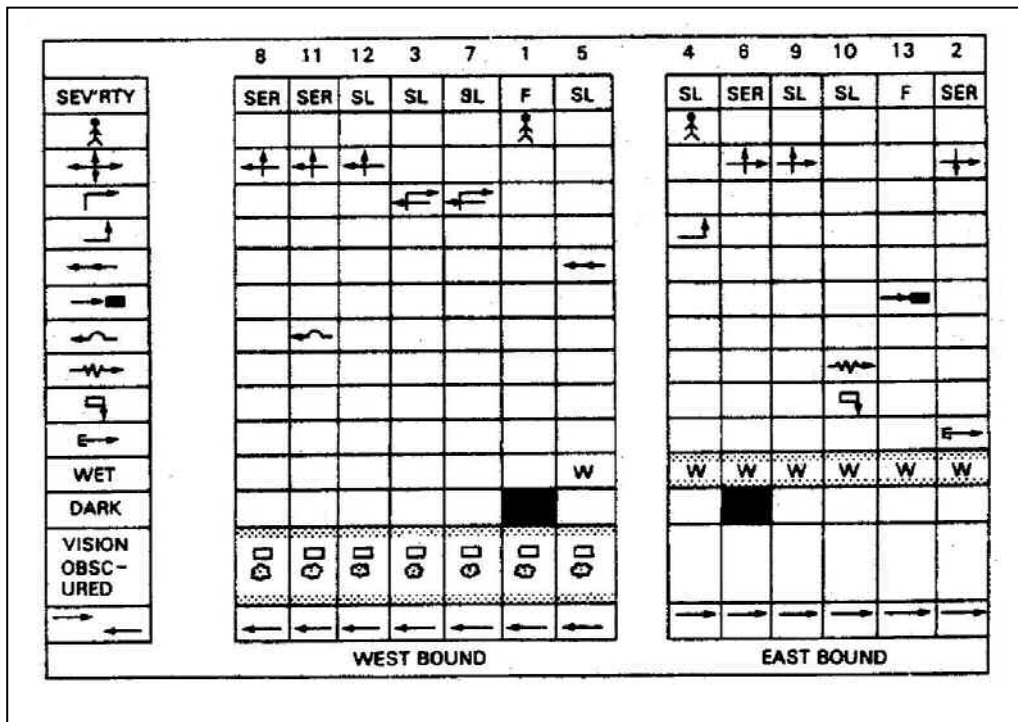

Dept of Transport, 1986

Figure 3-11: Example of manually-produced Stick Diagram Analysis with sticks sorted by direction of travel.

3.3.4 Monitoring study areas

Special software (e.g. TRL's MAAP; Buchanan's AccsMap) has been developed to help road safety teams monitor sites or areas that are or will be the subject of road safety programmes. Figure 3-12 shows an example of a program comparing accidents occurring at different study sites over the same time period; and Figure 3-13 shows an example of monitoring accidents before and after implementation of remedial schemes.



TRL MAAP for Windows/UK data

Figure 3-12: Ranking accidents at different monitor sites.

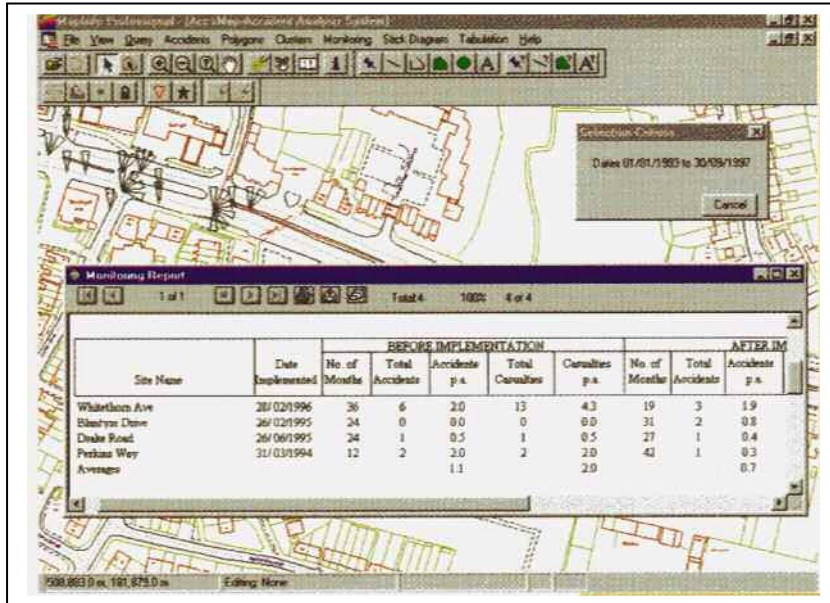

Buchanan AccsMap/UK data

Figure 3-13: Monitoring the change of accidents before and after implementation of remedial measure schemes

4 PROBLEM ANALYSIS: COLLECTING SURVEY DATA

This section describes survey data collection which forms the second major part of the Problem Analysis phase of USM. This will enable the USM team and the stakeholders to get a quantified picture of the current highway and traffic situation over the study area.

Examples of many of the survey forms required are presented in Overseas Road Note 11 (TRL,1993). The reader is recommended to refer to this document directly, but for convenience, the most pertinent forms supplemented with examples from other sources are reproduced here.

4.1 Engineering related data collection

4.1.1 Types of engineering related data that may need to be collected

The analysis of accident data for an urban area will provide a picture of the characteristics of the road safety problems, but it is the collection of data and observations on site that will provide clues as to the causes of particular accident types or clusters. The engineering related data should be collected in two phases:

- Phase 1: a rapid survey of the whole area; and
- Phase 2: detailed surveys of specific sites identified from the accident analyses

The general categories of data that potentially could be collected are shown in Table 4-1:

Table 4-1: Engineering related data types

Data type	Details	Essential	
		Whole area - Rapid assessment	Specific sites - Detailed
Road inventory	Establish road hierarchy over the area concerned	Y	Y
Geometric Cross-section (Engineering firm may be required)	Footpath or shoulder width, Carriageway(s) width, Median width (dual carriageways), Side slope profile (if appropriate)	Main roads and sample local and access roads	Y
Horizontal and Vertical Alignment (Engineering firm may be required)	Abnormal Gradient, Cross-fall Abnormal Curvature, Sight Distance	Y Y	Y Y
Land use	Housing, schools, shops, bars/pubs, commercial, industrial, recreational, bus stops, etc	Y	Y
Access points on major roads		N	Y
Traffic counts to establish modal splits on selected roads	HGVs, vans, cars, m/cycles, bicycles, pedestrians	Y	Y
Pedestrian facilities	Types of crossing, footbridges	Y	Y
Location of Traffic signals or Police controlled junctions		Y	Y
Vehicle manoeuvres at problem junctions		N	Y
Speed measurements at selected sites		N	Y
Parking and Parking Restrictions	Any parking on footpaths should receive particular attention	Y	Y
Encroachment onto the highway	Street stalls, etc	Y	Y
Street lighting	Assess quality (normally, luminance meters will not be available)	N	Y
Road signs and markings		N	Y
Abnormal features/Dangerous Locations		Y	N

This is clearly a long list of potential data to be collected and there is a real danger of collecting too much data and being overwhelmed by it. USM is a broader, strategic approach and requires less detailed information than that normally associated with single site treatment. For the second (site specific) data collection phase, it should be possible to design the surveys to concentrate on the particular accident types at the sites and avoid unnecessary data collection.

The first priority should be to concentrate on reducing casualties. For example, if it is found that there is a high frequency of child casualties, then the accident analyses should identify where and when these are occurring and the pedestrian surveys should identify what are the children's activities and traffic characteristics at these sites that might be leading to these accidents. As a second example, if greater than, say, 30% of accidents or casualties are occurring at night then a street lighting audit may be necessary.

4.1.2 Establish a link/node system over the area

If a Link/Node numbering system already exists for the area under study, then this should be used in normal circumstances. If it is not available, then a system needs to be established.

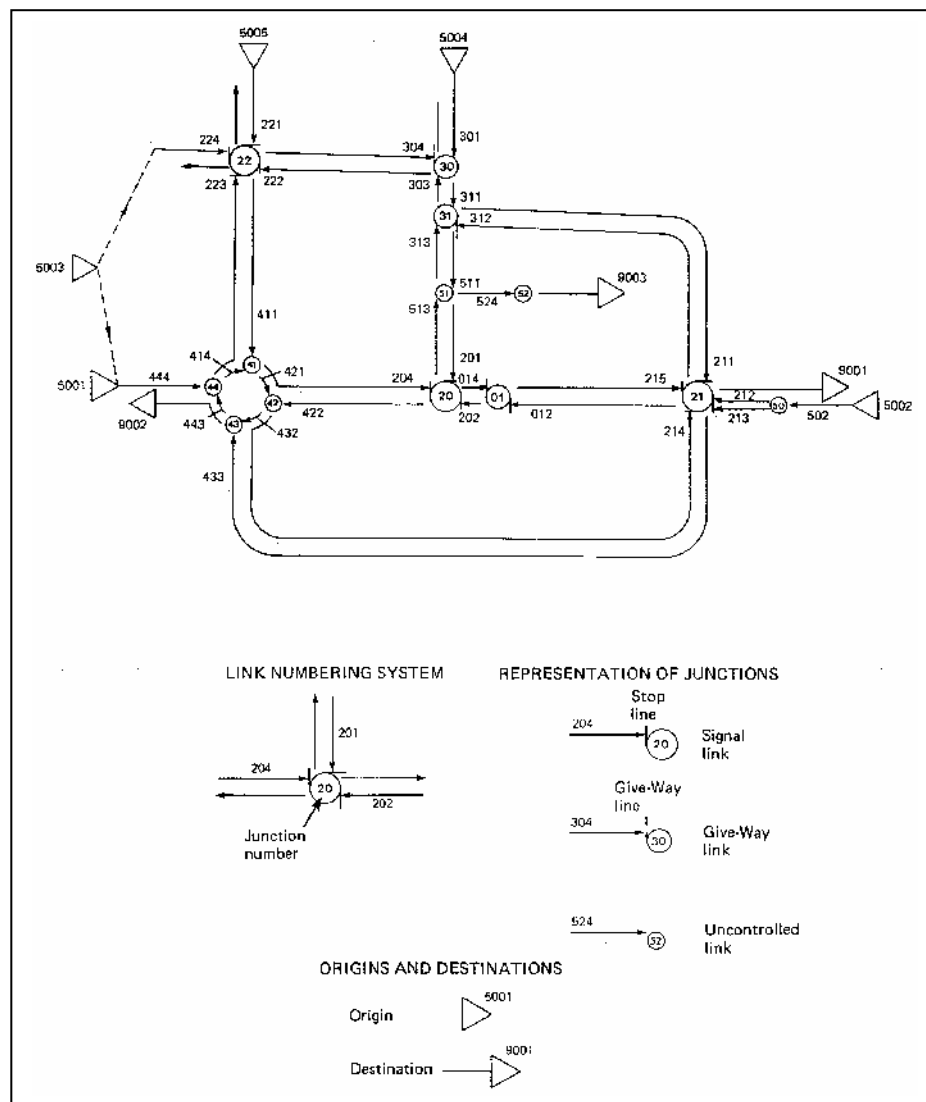

ORN 11 (TRL, 1993)

Figure 4-1: Coding a network

Each significant junction and road termination (e.g. at the end of a cul-de-sac) should be given a numeric reference number (Node number). A link or section of road between nodes can then either be defined by the two nodes at each end of the section or assigned its own unique Link Number even according to directions of travel (see Fig 2-1). The numbering of the nodes should be in a systematic progression through the network. Ideally the numbers should be banded according to the level of road, e.g. 1-99 for primary distributors, 100-299 for district distributors, 300-599 for local distributors and 600-999 for access roads.

4.1.3 Road classification: Identifying the present road hierarchy

The first task is to establish the existing road hierarchy. Figure 1-3 shows the schematic concept of a road hierarchy, with the function at the highest level being almost exclusively concerned with the movement of traffic (Primary distributor) and at the lowest level almost entirely concerned with access (Access roads). The cross-sectional design of the road should in theory progressively change from the lowest to the highest level, but in practice, in many cities, roads physically designed to be local distributors are acting as primary distributors.

This will initially be established from maps, observations and local knowledge but could be refined after traffic surveys have been conducted. An example of the identification of an existing road hierarchy is shown in Figure 4-2.

It may be necessary to conduct an Origin-Destination survey to establish the proportions of local and through traffic which may be required later in predicting the impact of remedial measures. OD surveys are dealt with in detail in Overseas Road Note11 (TRL, 1993).

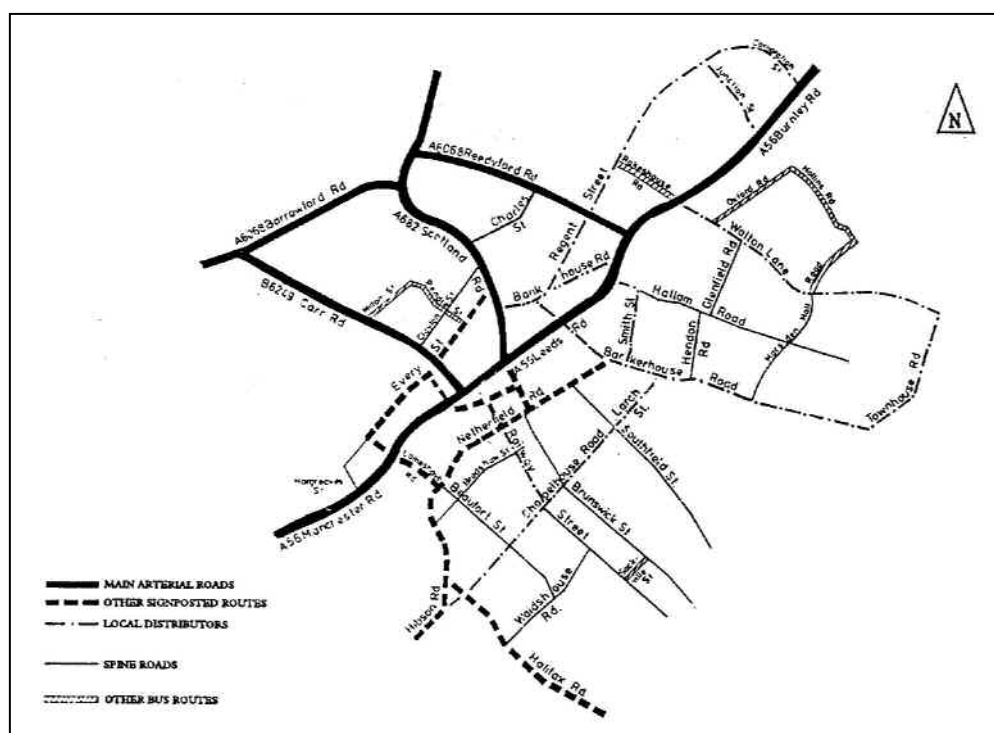

IHT, 1991

Figure 4-2: Identifying an existing road hierarchy in Nelson, UK

4.1.4 Vehicle classification system

A fully comprehensive classified count may identify up to 20 different vehicle types. However, it is rare that such detail will be required and in order to minimise survey difficulties, five or six groups will often be sufficient. An example of such a reduced classification is shown in Figure 4-3. In this example, the group or category number is based on the number of wheels/tyres on the vehicle.

CATEGORY	SUB-CAT	NAME	EXAMPLES
2	B	Bicycle	Adult, Child, Etc
	M	Motorcycle	Moped, Scooter
3	R	Leg powered Rickshaw	Pushing, Pedalled Freight Transport
	A	Auto Rickshaw	Other Powered 3-Wheeler
4	C	Cars & Light Vans	Car, All vans with only 4-tyres
	T	Taxis & Paratransit	Jeep, Pick-up, Private Mini-Bus, Micro-Bus
5+	P	Public Transport	Double Decker, Single Deck Bus or Coach with 20+seats, Passenger vehicles with more than 4-tyres
	G	Goods Vehicles	Rigid, Articulated, Trailer, All Vehicles with more than 4 tyres
L		Leg Powered	Hand Cart, Animal Cart
	O	Other	Tractor, Earth Mover, Tram Car, Other

ORN 11 (TRL, 1993)

Figure 4-3: Simplified vehicle classification

4.1.5 Land use survey map

In Phase 1, a rapid survey of the Land Use of the whole area should be carried out, by car or on foot. An example of a Land Use survey map so established is shown in Figure 4-4.

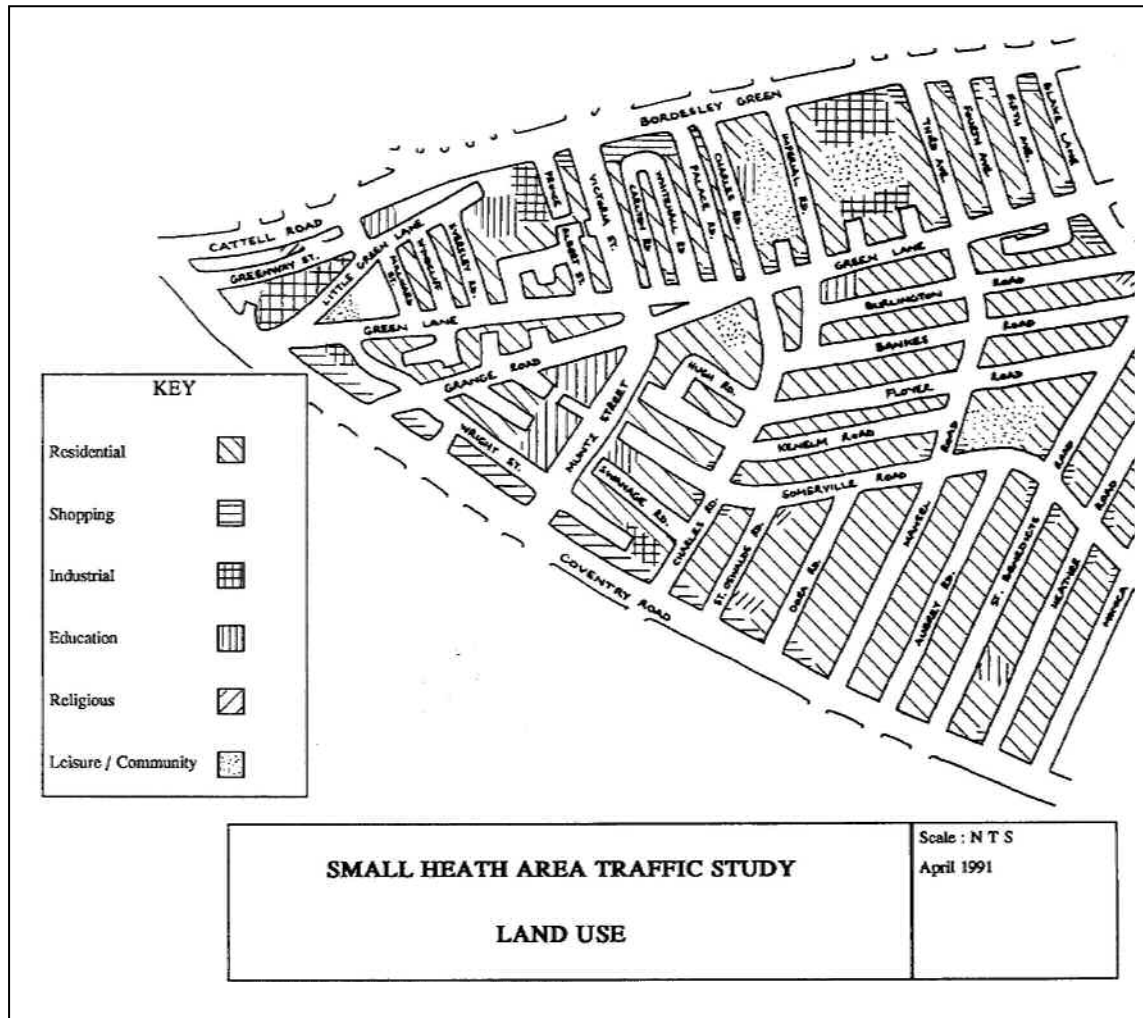

RoSPA, 1992

Figure 4-4: Example of a land use survey map

4.1.6 Detailed link inventory

The road infrastructure consists of links, junctions, parking spaces and terminals. The physical characteristics which will influence its use include its current geometrics and pavement structure, its traffic controls (signs, signals, road markings, and parking restrictions), sidewalks, shoulders, adjacent land use, service provision (for example, gas, water, electricity, telephones) and the intensity of non-traffic activities which encroach upon road space (for example, hawkers, builders' materials, market stalls etc.). The purpose of the inventory survey is to record this information.

The detail of an inventory survey can be varied to suit needs. An approximate, but simple survey method involves surveyors walking or driving along a link, and locating objects or points by the distance (chainage) along the link and the off-set from the centre line. Chainage can be taken from a vehicle odometer or measured by pacing, or measuring wheel. As far as possible, inventory surveyors should be restricted to observation and measurement, as opposed to making any judgements. Figure 4-5 shows an example of a completed survey form demonstrating the level of detail which can be recorded.

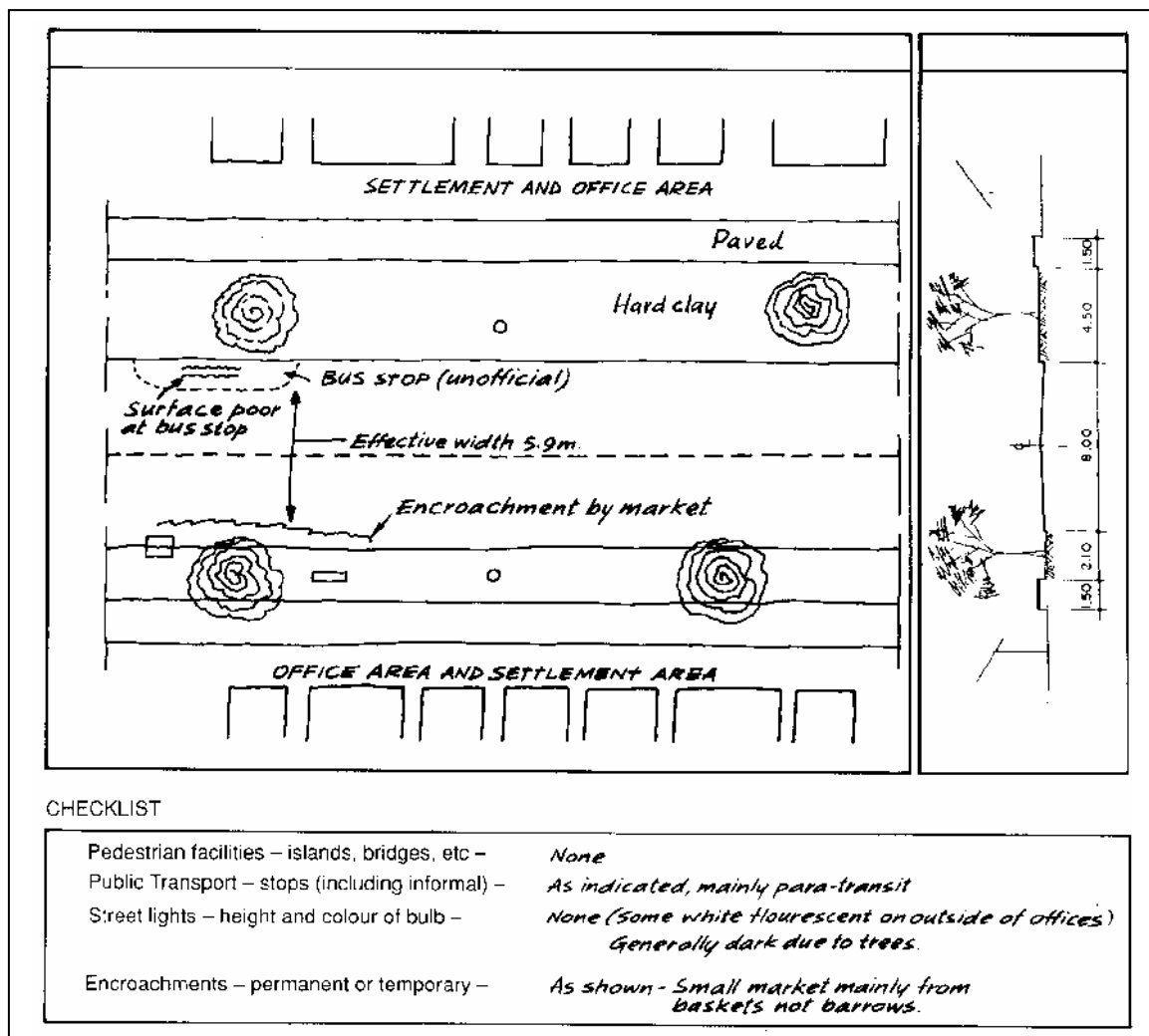

ORN 11 (TRL, 1993)

Figure 4-5: An example of a completed link inventory form

The rate of progress of an inventory survey obviously depends upon the data items to be noted and the accuracy of measurements. However a simple link survey for traffic planning purposes should progress at approximately 0.5 - 1.0 km/h. Link surveys can be carried out by pairs of surveyors, one surveying to the left of the centreline, and the other to the right.

The field sheets themselves are the main output from the survey. They should be filed and referenced to a master map showing the area covered by each field sheet. Individual road links (and junctions) are referenced using the system of link and node numbering.

4.1.7 Detailed junction inventory form

Detailed junction surveys would generally only be required at a later stage in the USM process when a junction has been identified as having a particular accident problem. Such details might include, for example, measurements of corner radii and turning restrictions. Figure 4-6 shows an example of a Junction Inventory form.

JUNCTION INVENTORY				
Overseas Unit, TRL, Crowthorne, UK			Form C	
SITE NAME		Site Ref. No.	Surveyor(s) & Supervisor	Sketch
Date	From	Time To	Weather	NOTES
Junction Type	Cycle Time	Controller Type		Sheet
				1 of 1
N = North SP = Survey Point CBD = Central Business District				

X CHECKLIST:

- Pedestrian Facilities - islands, bridges, etc.
- Public Transport - stops (including informal)
- Street lights - height and colour of bulb
- Encroachments - permanent or temporary

Y SIGNALS EQUIPMENT:

- 3 aspect primary signal
- 3 aspect secondary signal
- filter arrow
- pedestrian signal
- signal mast assembly
- signal controller box

ORN 11 (TRL, 1993)

Figure 4-6: Example of a junction inventory form

4.1.8 Detailed parking inventory form

This survey requires a base map, upon which the surveyor marks the location and number of parking spaces. The map should be approximately 1:500 scale, depending upon the amount of detailed information to be recorded. A sketch map is perfectly adequate (Figure 4-7 for example), but officially published maps may be preferred. The parking inventory may also be incorporated into the road link and junction inventory maps. Where more than one form is required for a study area, a master reference map of the study area will be necessary, showing the area covered by each sketch sheet.

The location and number of formal parking spaces is usually determined easily because the spaces are marked. The number of informal parking spaces requires some judgement. Kerbside car parking spaces can be assumed to be 6 metres long and 2.5 metres wide. For informal areas, it is necessary to count the actual number of parked vehicles at a time of peak demand.

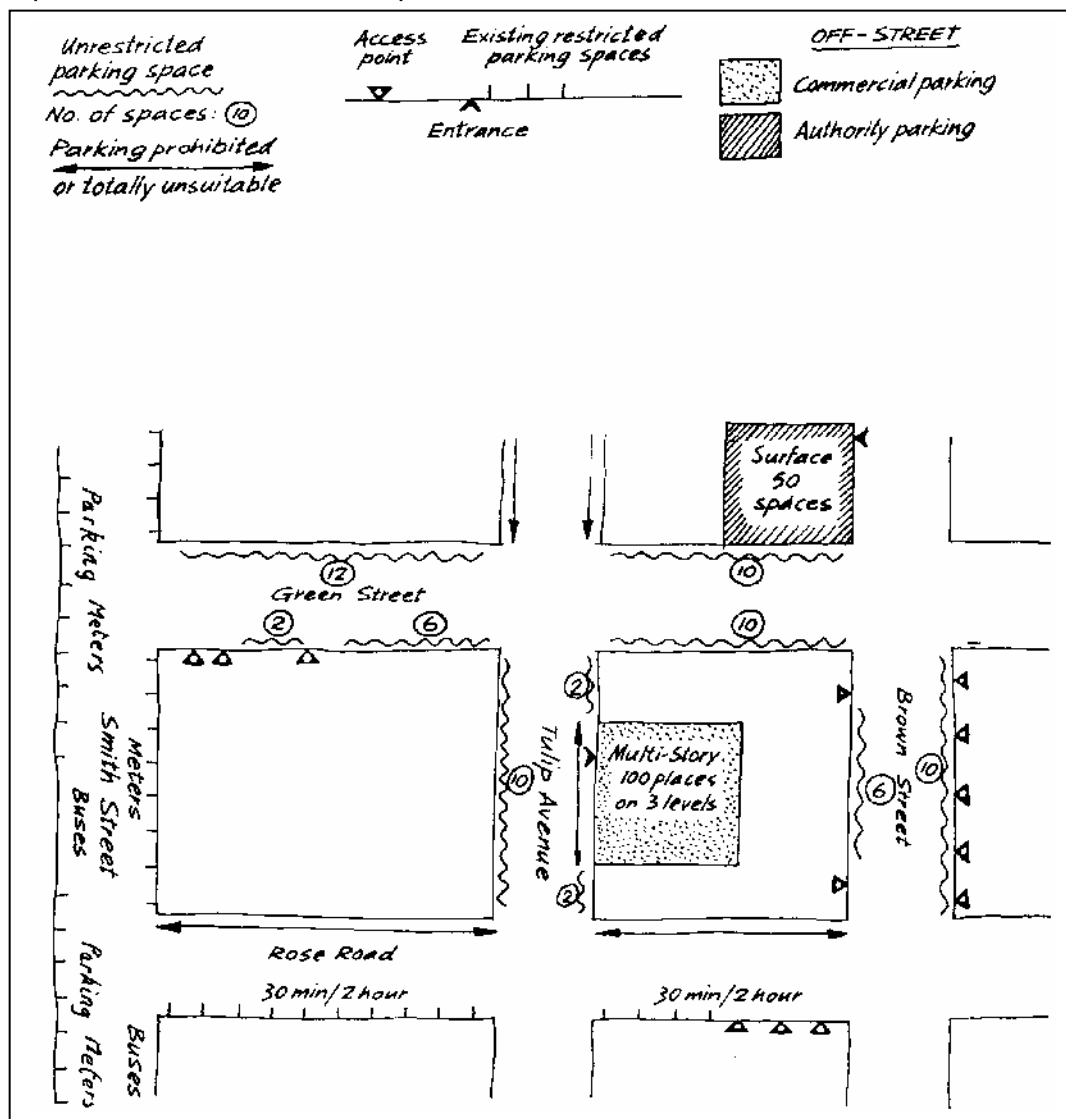

Wells, 1974

Figure 4-7: An example of a parking inventory survey

4.1.9 Traffic counting and classification

The purpose of these surveys is to collect data on the number and types of vehicles passing a specified point on a link (link counts), or making specified movements at a junction (turning counts). Volume of traffic is expressed as a rate of flow, usually either as vehicles per hour (veh/h), in particular, the peak hour demand on the road, or vehicles per day (veh/day), often converted into the value "AADT" (Annual Average Daily Traffic).

By definition AADT can only strictly be from a continuous count over a full year. However, factors for modifying short period counts to estimate AADT can be developed using long period counts for a limited number of sites which are chosen to represent the main types of road in the network. The annual counts at the sample sites will indicate seasonal, daily and hourly variation and hence the factors which relate traffic volumes (measured at any specific time) to the AADT, for that class of road (see AASHTO, 1992; TRL, 1965).

Traffic volume surveys are carried out by either manual or automatic traffic counts. Manual counts are particularly useful for vehicle classification, checking automatic counter accuracy, and surveying vehicle occupancy. Automatic traffic counts, using traffic counter equipment, are normally used only on links, and are particularly suitable for long-term data collection, and analysis of seasonal, daily, and hourly variations. In most studies, a combination of automatic and manual counts is needed.

In a manual count a surveyor stands by the roadside, counting and classifying the vehicles as they pass, dividing the survey into fixed time periods. It is normal for the surveyor to record only one direction of flow unless counting on a low-volume road.

Link counts should be located on straight sections of road with good visibility. The duration can be from a few minutes to several days, depending on purpose. Most counts are carried out for one day, starting before the morning peak hour, and extending for 12, 14 or 16 hours. Count periods are usually 15 minutes, with results summarised hourly. Even when hourly counts are the most detailed data required, 15-minute periods should be used as errors are more easily identified (particularly start-up and close-down errors). Also, the start of the peak hour initially may not be known; counts divided into 15 minute periods will capture whichever four consecutive periods summate to the largest number.

Turning movement counts are carried out in the same manner as link counts, except that the turning movement of each vehicle is recorded, and the vehicle classification system is simplified (to compensate for the extra demands on observers). These surveys are primarily concerned with the performance of the junction during peak periods, and survey duration is often confined to the morning and afternoon peak periods, typically between 2 and 4 hours each. Count periods are usually 15 minutes. However, at signalised junctions short-term volumes are determined by signal operations, and cycle times in excess of 2 minutes, or count periods less than 15 minutes, may cause apparent fluctuations in flow. In such cases it is best to record flow for each cycle, using the cycle time as the counting period.

Survey forms must be designed for the specific needs of the study. Typical examples of completed field forms are shown in Figure 4-8 which also illustrates two common pencil-and-paper methods of recording and classifying each vehicle. The 'five-bar gate' method is the most versatile and is applicable to both link and turning counts. It records data quickly (without the need for extreme neatness), is the most economical in use of space on the survey form and can be summarised quickly. The 'crossing out numbers' method is best with low or medium continuous flow. It is the least flexible of

the methods and has the slowest recording rate. However, there are no problems of surveyors 'losing count', and totaling is immediate.

Alternatively, hand tallies can be used to record specific vehicle classes. They are faster and more accurate than pencil and paper methods, because only the total is recorded, at the end of each count period, and the surveyor is able to look at the traffic flow almost continuously.

Problems with hand tallies and manual counts in general together with automatic traffic counters are further discussed in Overseas Road Note 11 (TRL, 1993)

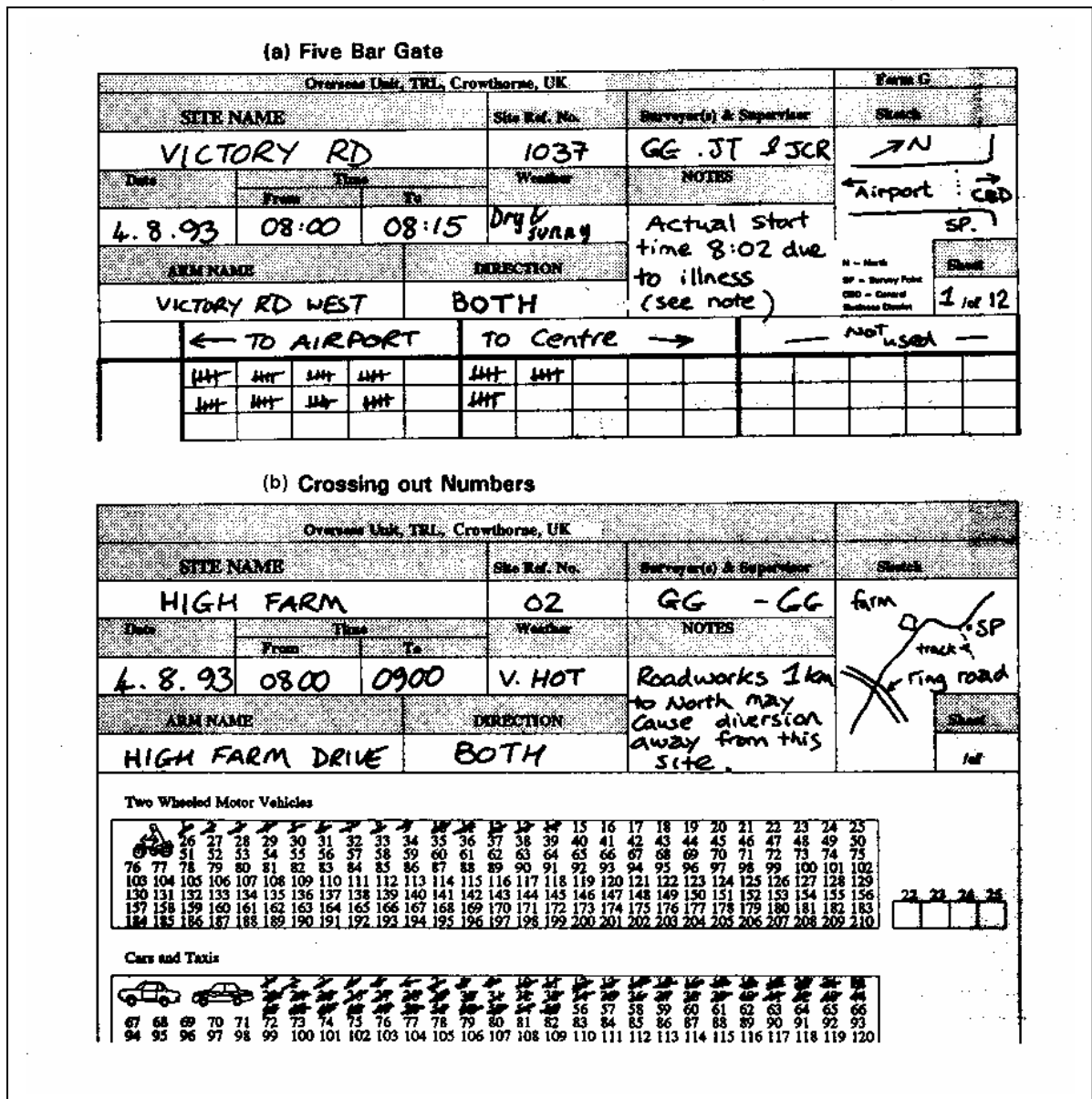

ORN 11 (TRL, 1993)

Figure 4-8: Alternative methods of traffic logging

Examples of presenting traffic volume data are shown in Figs 4-9 and 4-10. These include: volume maps, with a geographical background overlaid by bandwidths representing traffic volumes (see Fig 4-9); desire line diagrams, more often used for Transport Planning Studies, but which can also be useful in the planning stages and junction turning movements (see Fig 4-10).

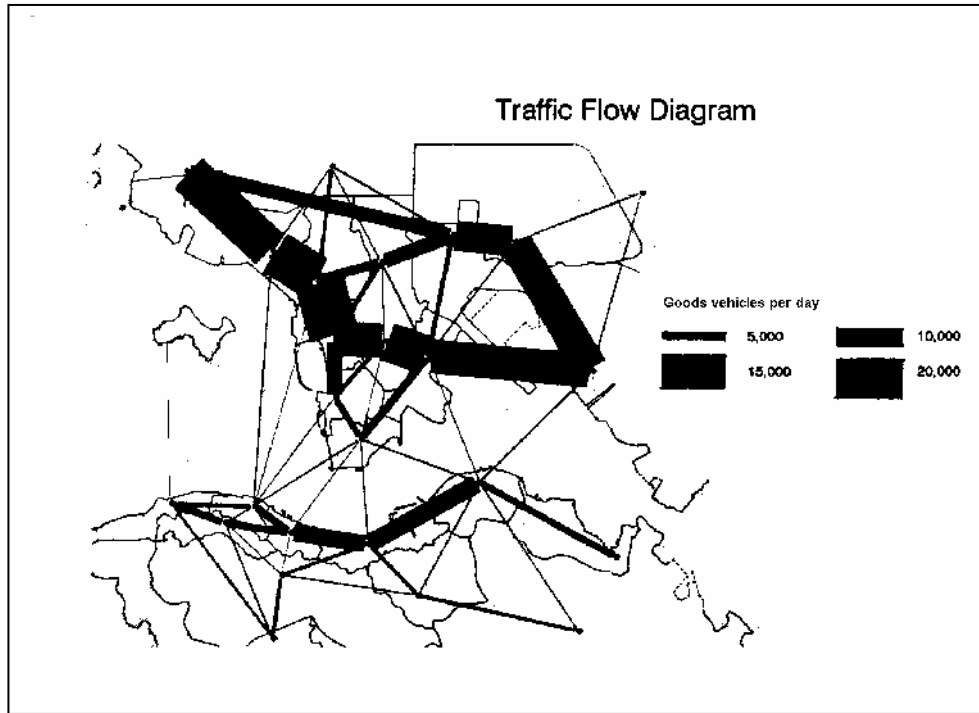

ORN 11 (TRL, 1993)

Figure 4-9: Presentation of network traffic data

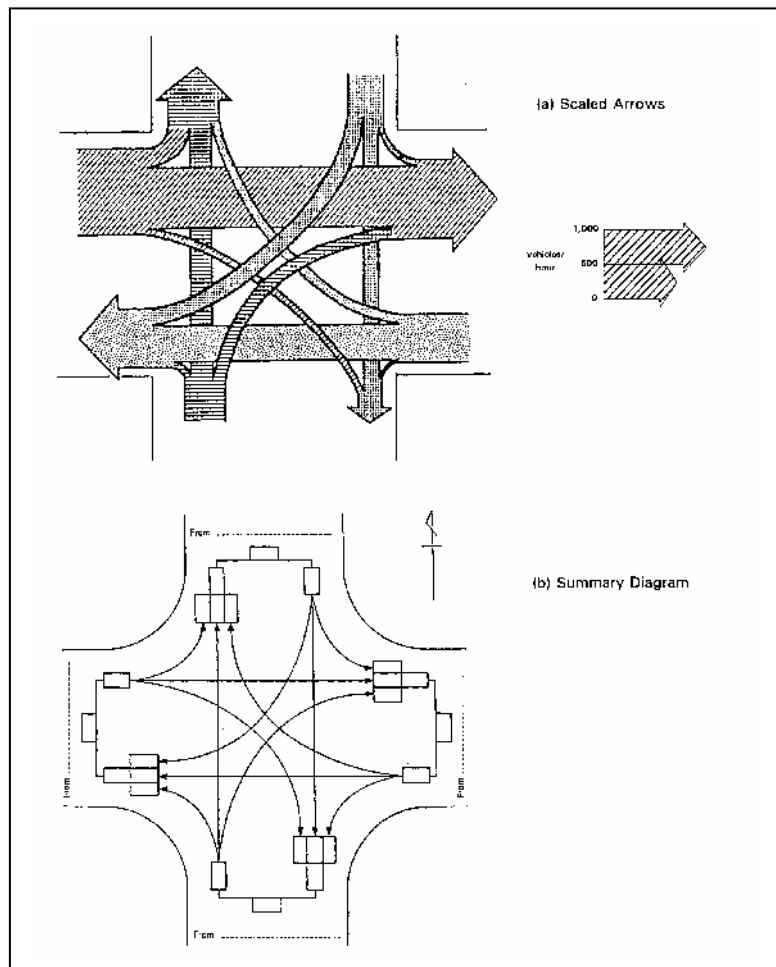

ORN 11 (TRL, 1993)

Figure 4-10: Presentation of junction count surveys

4.1.10 Moving car observer method for measuring traffic flow and journey speeds

This method of obtaining estimates of traffic flow and journey speed along a road or route was developed by Wardrop and Charlesworth (1954), and is best suited to the higher speed, relatively low-flow roads where overtaking opportunities are frequent. An observer travels over a known length, L, of highway and the travel times for the journeys both with (t_w) and against (t_a) the stream are noted. In doing this, the driver is instructed to travel at the legal speed limit except when impeded by the traffic conditions. Whilst travelling along the highway with the traffic stream under study, the observer notes the number of vehicles which overtake the observer minus the number of vehicles overtaken by the observer (y). The observer then travels against the traffic stream under study and notes the number of vehicles met (x) in the stream under study. A number of runs are made over each route, and the flow, q , is then given by:

$$q = \frac{x + y}{t_a + t_w}$$

and the mean stream journey time, t_m , is given by:

$$t_m = t_w - (y/q)$$

The average stream speed, v_m , can then be calculated from the known length of the highway:

$$v_m = L / t_m$$

If the resources are available, it is better to use two vehicles travelling in opposite directions at the same time. This eliminates any change in traffic conditions on the two opposite runs by a single vehicle.

For low and moderate traffic flows, the following form would enable the two opposing directions or streams to be observed with just the two runs. With heavy flows it may be more practical to just study a single stream at a time, recording just Overtaking/Overtaken travelling with the stream and Met when travelling against that stream.

Date:

Observer:

Journey from (A):

to (B):

Distance:

Trip times		Vehicles			Comments/ Delay details
Commences	Ends	Overtaking	Overtaken	Met	

Journey from (B):

to (A):

Trip times		Vehicles			Comments/ Delay details
Commences	Ends	Overtaking	Overtaken	Met	

Figure 4-11: Form for moving-car: volumes and journey speeds calculations

This is known as the *corrected moving observer method*. During the runs, the observer can record the location, duration and causes of any stoppages.

4.1.11 Counting pedestrians

Because pedestrians are the most vulnerable of road users and frequently the largest class of casualties in urban areas, these counts are perhaps the most important of any of the surveys. The purpose of the counts is to get an indication of the likelihood of pedestrian/vehicle conflicts to help justify and plan future pedestrian facilities. The counts will not only help in deciding the location and design of measures, they will also help in later evaluation by serving as 'before' data.

Counts should be made of both pedestrians crossing the road and pedestrians walking along the road or on the footpath. The sex of the pedestrian should be recorded. For age, either a simple classification of whether or not the pedestrian is an adult or child (eg. Under 15 years old) could be made; or an estimate of the child's age could be made.

A good deal of flexibility is required in organising the survey. The number of observers and locations point will depend very much on the pedestrian volumes and local circumstances. The following survey plan is an example for counting pedestrians crossing the road. The highway is divided into zones, and one or more observer allocated to each zone. The pedestrian counts are for the whole zone. Observers should only count those pedestrians starting their crossing manoeuvre in their zone. In crossing the road, some pedestrians may cross diagonally and go from one zone to another. To avoid double counting, observers should only count those pedestrians starting their crossing manoeuvre in their zone. The limits of each zone should be made clear to the observers, for example, by using traffic cones.

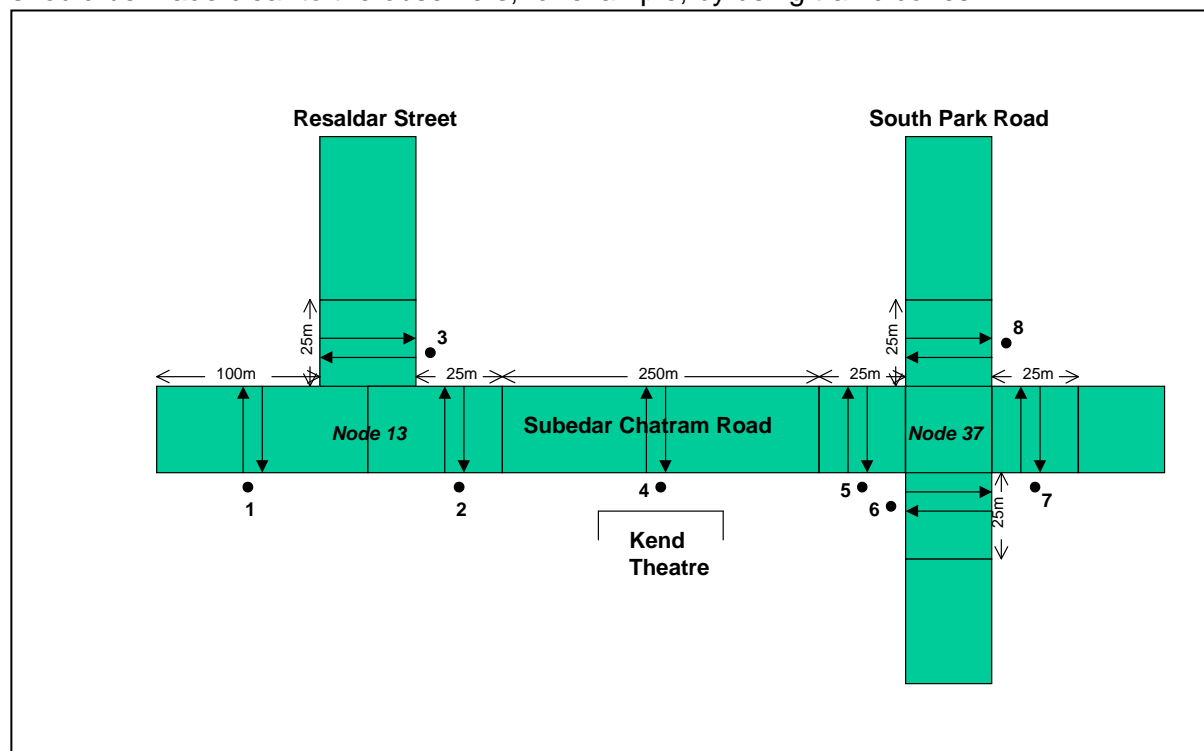

Bangalore Case Study, Annexe 1

Figure 4-12: Survey plan for counting pedestrians crossing the road. Eight observer points are indicated.

Figure 4-13 shows an example of a form for recording the pedestrian counts. A five-bar gate method of recording each pedestrian in each category can be used. The size of each recording cell may be adjusted as necessary for the volumes encountered.

Pedestrian Count Form: <i>Pedestrians walking along road or on footpath</i>						
OBSERVORS INITIALS:			Date:			
ROAD NAME:						
ZONE CODE:						
Direction of travel:						
ALONG ROAD				ALONG FOOTPATH		
15 MINUTE TIME PERIOD STARTING AT:	Number of:			Number of:		
	MALE ADULTS	FEMALE ADULTS	CHILDREN <15years	MALE ADULTS	FEMALE ADULTS	CHILDREN <15years
08:00						
08:15						
08:30						
08:45						
09:00						

Figure 4-13: Example of classified pedestrian count form.

These results can then be entered into a spreadsheet with the same format. Figure 4-14 shows an example for presenting the summary analysis of the data. The pedestrian counts for crossing the road in two directions are shown for a number of sites.

Analyses of the pedestrian counts by time of day are one of the essential cross-tabulations (eg see Figure 4-15 which shows differences in pedestrian volumes and peak crossing between zones). Taken with analyses of traffic counts and accidents by time of day may reveal whether safety problems occur when traffic and pedestrian volumes are high, and probably speeds lower, or when volumes are off-peak and speeds higher. This may then affect the selection of countermeasure.

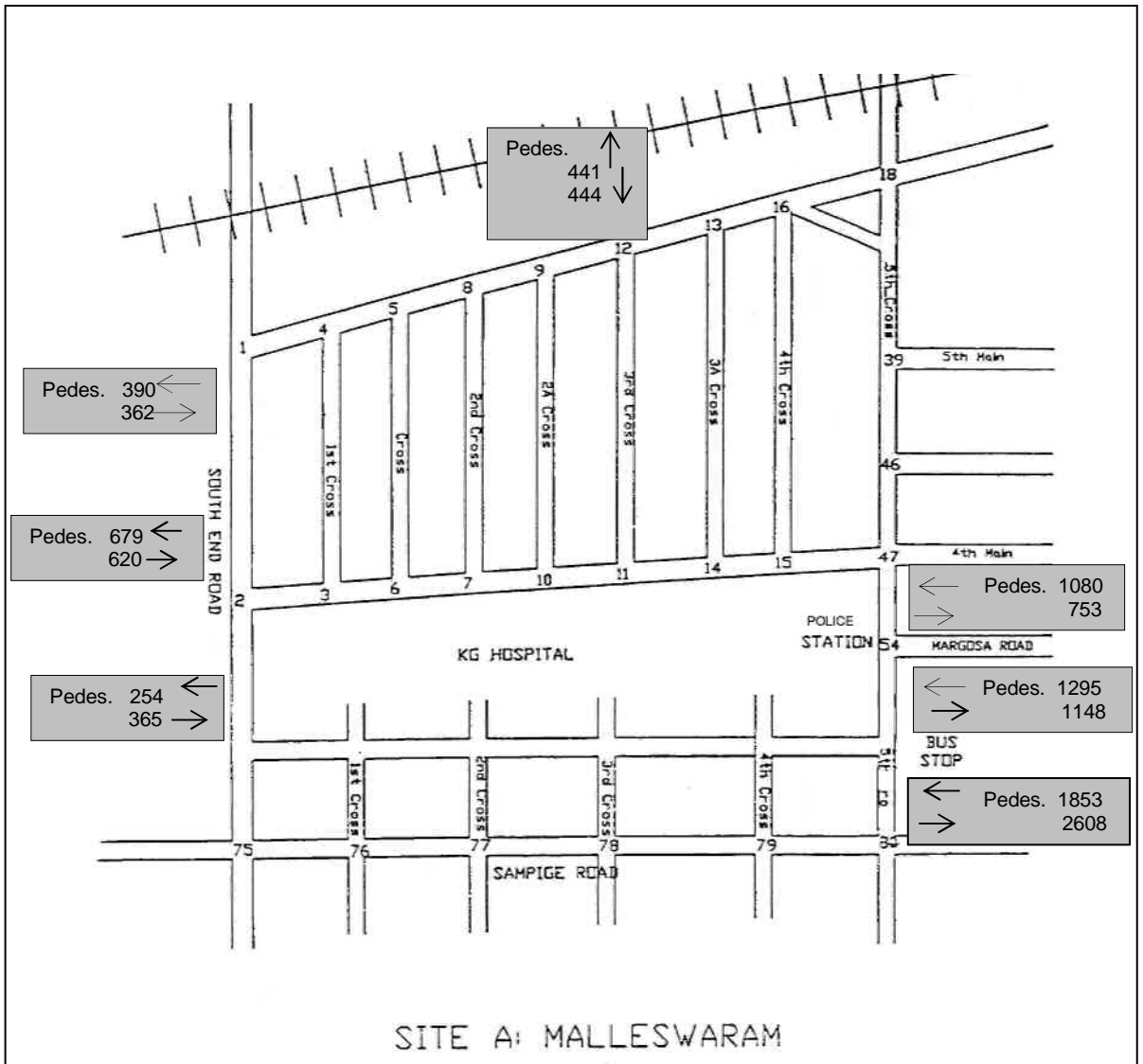

Bangalore Case Study,

Annexe 1

Figure 4-14: Analysis of 9-hour pedestrian counts for a site in Bangalore

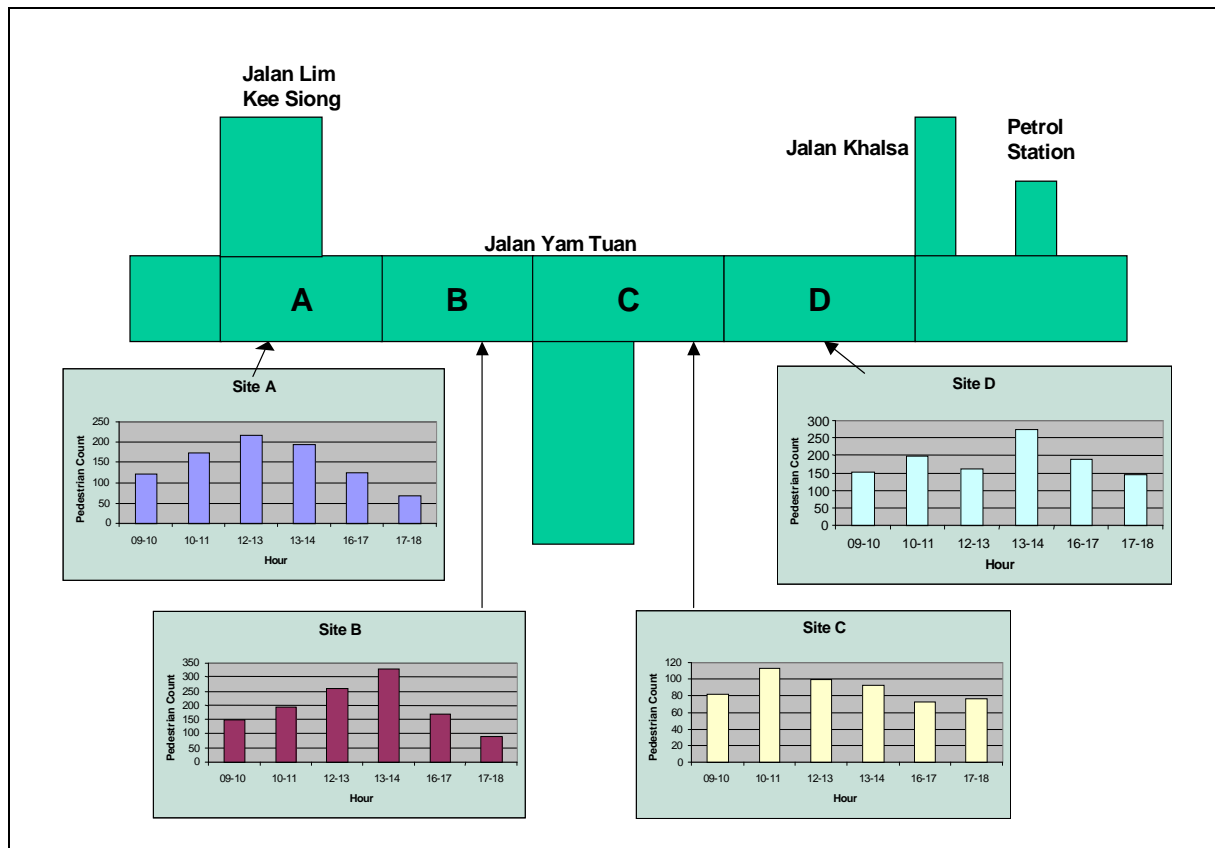

Adapted from Baguley (1995)

Figure 4-15: Example of histogram analyses of pedestrian counts.

4.1.12 Speed Surveys

Spot speeds are usually measured on links (not at junctions) and are surveyed separately for each direction, with the observer normally positioned on the side of the road of the direction being monitored. Spot-speed data is collected by either a radar or laser speed gun (which gives automatic direct measurement) or short-base methods: timing a vehicle over a known short distance, either manually with a stopwatch or automatically using modern loop or twin-tube devices.

Radar speed guns are suited to relatively narrow roads at low or medium flows, when vehicles travel past the observer individually. They are not suited to heavy traffic volumes, congestion or multi-lane roads. Furthermore, they require significant training of survey staff, and are expensive. Methods where vehicles are timed over a short base line are suitable for almost all traffic conditions and types of road. They require only simple and inexpensive equipment, and are less obtrusive; the main problem is overcoming parallax error. This is reduced if a high vantage point is available (eg. Figure 4-16).

The presence of surveyors, equipment, or unusual markings on the road surface can affect driver behaviour. The need to make the surveyors inconspicuous can thus affect choice of survey method and location.

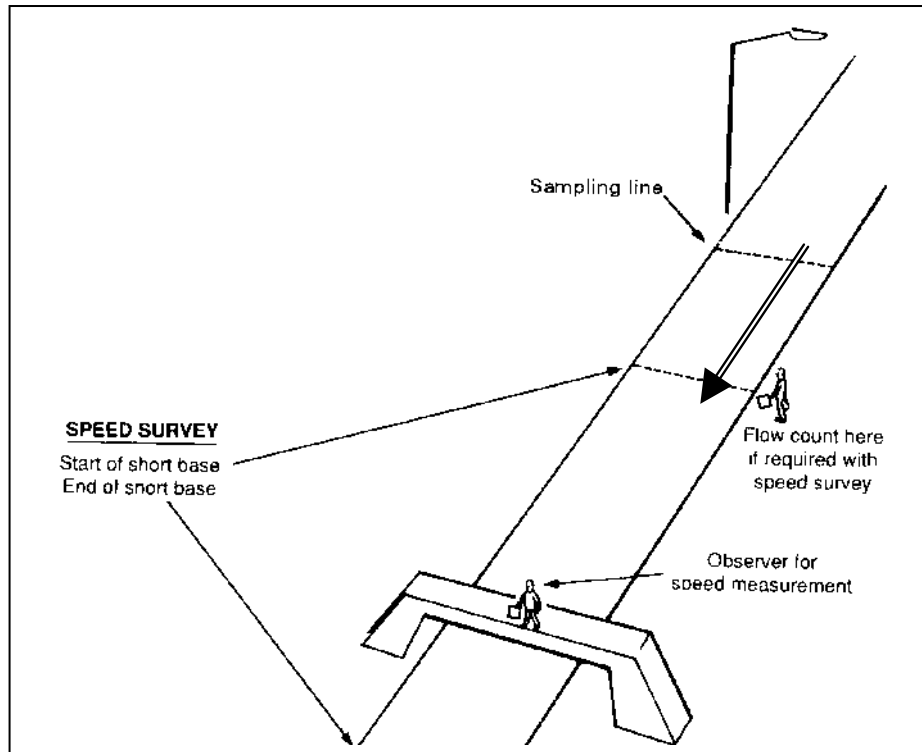

Figure 4-16: Speed survey using 'Short-Base' method

4.1.13 Radar and laser speed guns

The location of the survey, sampling of vehicles and recording of results, are exactly the same as for the manual short base method described below. The main requirements of the speed gun are that the operator is fully trained on the accurate use of the equipment and that the speed gun, and its operator, are concealed from drivers. Measurements can be made from inside a parked car, but the car should not be parked in any location which affects the speed of the vehicles surveyed.

4.1.14 Manual short-base method

The survey location is usually at the middle of a road link. A specific point is created on the link, determined if appropriate by the study objectives (for example at a pedestrian crossing, to investigate an accident problem). A short-base length is created, over which vehicles can be timed. The length will depend on speeds on the road, with longer bases needed for higher speeds. Table 4-2 relates approximate lengths to average speeds.

Table 4-2

Short base lengths	
Average speed of traffic (km/h)	Short-base length
Below 40	25
40-65	50
Above 65	75

Another approximate guide to length is that no vehicle in the traffic stream should take less than 2 seconds to traverse the short-base, in the traffic conditions prevailing during the survey.

The ends of the short-base length are marked on the road surface with paint, chalk, or tape lines; the lines should be as inconspicuous as possible to drivers. Alternatively, the downstream line can be defined by the surveyor standing directly opposite a roadside object (for example, a power pole or tree) on the opposite kerb. The observer must always be at the downstream end. The short-base length must be measured accurately, preferably with a metal tape-measure rather than a measuring wheel. In addition a "sampling line" is marked upstream of the start line. The sampling line is needed so that the observer can select the sample vehicle before he starts to record its travel time. The observer must be able to see the sampling line and both timing lines, for all lanes of traffic; the pilot survey should determine whether a high vantage point is required.

Sample vehicles are selected at the "sampling line". The survey supervisor should define which vehicles are to be included. This might be every n^{th} vehicle or according to some other method to ensure an unbiased sample (For example, as the surveyor looks up he notes the first vehicle in any lane to cross the sampling line and selects the next vehicle in any lane to cross the sampling line.

This is the "sample vehicle". The observer starts the stopwatch as the sample vehicle crosses the upstream start line, and stops it as the same vehicle crosses the downstream line. The time is recorded on the survey form, together with vehicle type and whether or not it was a following vehicle in a platoon. The procedure is repeated for the next vehicle, and so on through the survey period. Both timing and recording can be completed by one surveyor using the form shown in Figure 4-17.

Spot speed surveys are usually concerned with the non-peak periods of traffic flow, when speeds are higher. For example, where free-flow speeds are needed for setting speed limits, periods of low volume and good weather are specifically chosen.

4.1.15 Output

Vehicle speeds are calculated from the times and known short-base distance. Results may be presented numerically or graphically. The most common graphical outputs are histograms and cumulative distributions of speeds which allow the extremes of the speed range to be seen.

Numerical results can be: mean speeds; the range of speeds; the proportion of vehicles above or below a certain speed (for road safety and enforcement). The 85th percentile is commonly used to describe speeds. This excludes extremely fast drivers (and gross measuring errors) and gives an estimate of what the majority of drivers consider a top limit.

4.1.16 Recording hazardous and abnormal features

A special visual safety audit of the area under study may be carried out, or as the engineering data is gathered, a special inventory of problems may be gathered. In combination with the other surveys, key problems will then be identified. Figure 20 of Annexe 2 shows with photographic examples the main hazards identified in Malleswaram in the Bangalore case study. There were two causes of problems identified; those due to poor design of the road and those due to driver and pedestrian behaviour. It was considered that both modes could be overcome by using engineering to amend the road environment and reinforce the hierarchy (see proposed traffic calming measures in Figure 41 of Annexe 2).

SPEED SURVEY ALONG MEASURED BASELINE										
Overseas Unit, TRL, Crowthorne, UK									Form J	
SITE NAME			Site Ref. No.		Surveyor(s) & Supervisor			Sketch		
Date			Time		Weather			NOTES		
			From To							
Arm Name		Direction		Width (m)	Baseline Length (m)				Sheet	
									<small>N = North SP = Survey Point CBD = Central Distress Point</small>	
Clock Time	Vehicle Type	Time Taken		Notes/ Delays	Speed kph	Clock Time	Vehicle Type	Time Taken	Notes/ Delays	Speed kph
<small>hh mm</small>		<small>mm ss</small>				<small>hh mm</small>		<small>mm ss</small>		

Speed (km/h) = 3.6X Baseline Length/Time Taken (secs.)

Vehicle Types					Reasons for Delay (with codes where used)					
Group	Code	Description	Group	Code	Description					
3-	2B	Bicycle	5+	SP	Bus (>5 tyres)	S -	Signals	Roadworks - Diversion		
	2M	Motorcycle		SG	Goods (>5 tyres)	J -	Other Junction	Accident - Breakdown		
	3R	Pedal Rickshaw		L	Leg-powered	P =	Pedestrians	Flooding - Weather Extremes		
4	3A	Auto Rickshaw		O	Other	B =	Bus or Paratransit	Encroachments		
	4C	Cars-Vans				K =	Parked or Loading	Police Intervention		
	4T	Small Paratransit				N =	Not Delayed	Unknown - Other		
						X -	Part of platoon	not at free speed		

ORN 11 (TRL, 1993)

Figure 4-17: Example of speed survey form using the short base method

4.1.17 Use of video

Data collected for many of the measures described above can also be achieved by analysis in the office by suitable video film. Film taken by a car passenger even using windscreen-mounted camera whilst driving around a car network will provide a very useful record for future reference. Digital video film in particular can be a source of still pictures to subsequently illustrate proposal reports. If observer manpower is lacking, then video film can be used in passing-car measurements or from stationary camera positions to make designated vehicle manoeuvre counts or even measure speed if suitable camera positions can be found.

4.2 Further Behaviour, Education and Enforcement related data

It will be noted that a number of behavioural measures, such as vehicle speed and pedestrian crossing behaviour, will have been surveyed under the engineering and planning surveys discussed above. However, these surveys will not normally include studying other possible accident-producing behaviours such as drink driving, red light running, dangerous overtaking or close following. These types of behaviour are more likely to be influenced by education and enforcement measures in the USM project, and it might be considered necessary to conduct some special studies which, at their broadest, could possibly include:

- A review and evaluation of current driving and pedestrian behaviour.
- Identification of key causes of such behaviour.
- A review the system of driver's education and the role of insurance companies in providing benefits for good driving behaviour.
- A review of penalties for improper or dangerous driving behaviour and the ways some drivers might seek to avoid penalisation, and
- A review to identify methods and steps to be taken to improve such behaviour patterns.

The behavioural surveys can use variations upon the forms and techniques, such as video recording, that have been discussed in the previous sections. A detailed description of the procedures for conducting a Drink Driving survey has been given by Hills et al (1996).

4.3 Identification and prioritisation of the poor

In identification of stakeholder groups and potential beneficiaries of USM strategies, there are a range of key poverty indicators to consider when prioritising poor and vulnerable areas for intervention. The list of urban poverty indicators in Table 4-3 are by no means exhaustive, but provide a checklist of assets available to the urban poor that signify degrees of poverty.

Table 4-3: Key poverty indicators for identification of the urban poor

<p>Homelessness</p> <ul style="list-style-type: none">• No rights to property or land <p>Household Income Range</p> <ul style="list-style-type: none">• Income from formal/informal employment, pensions or remittances• Head of household (male or female)• Unemployment rate amongst economically active members of the household (excluding children) <p>Condition of Property</p> <ul style="list-style-type: none">• Proximity to roads and other dwellings• Size of property• Number of rooms• Number of inhabitants• Construction materials: walls and roof <p>Asset Ownership</p> <ul style="list-style-type: none">• Land tenure/property• Vehicle (motorised/non-motorised)• Furniture• Access to electricity, potable water and sanitation <p>Access to Social Services</p> <ul style="list-style-type: none">• Proximity to primary health care facility• Proximity to primary and secondary schools <p>Expenditure</p> <ul style="list-style-type: none">• Proportion of household expenditure on:• Transport• Health• Education• Rent• Savings• Consumer goods
--

These 'headline' indicators have been applied to a procedure for integrating poverty into USM, found in **Figure 4-18**.

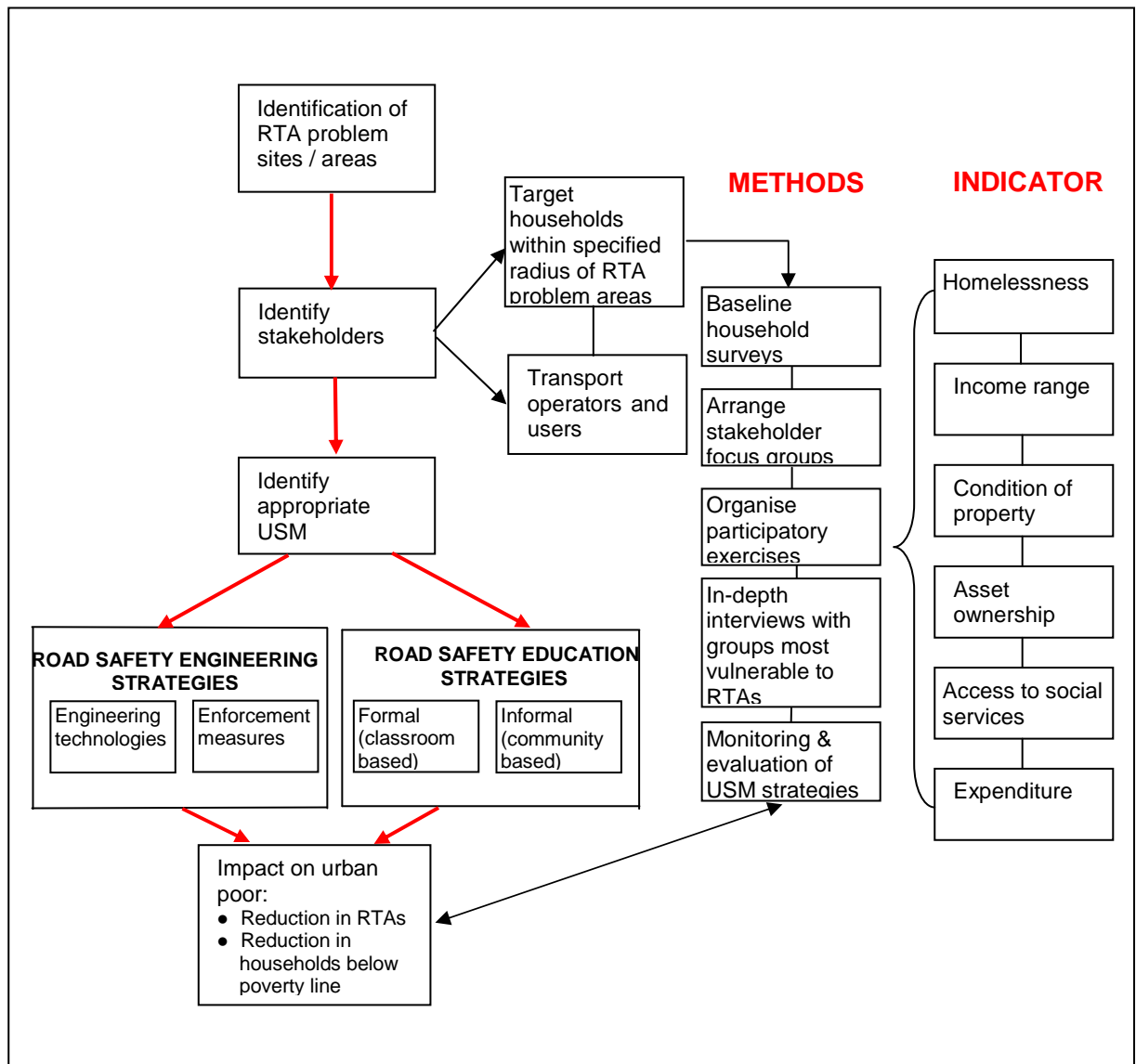

Figure 4-18: Procedure for integrating poverty into urban safety management schemes

Finally, another requisite for applying urban safety management is to identify the *need* for intervention and to forecast potential impacts (both positive and negative) of investment in road safety strategies on the poor, in order to avoid unnecessary wastage of donor funding. Consequently, there is a need to communicate the priority requirements of urban communities to transport practitioners and decision makers, to ensure that appropriate interventions meet the needs of the poor rather than serve to exacerbate their vulnerability. It is difficult to anticipate the short and long term effects of major engineering interventions, but suitable consultation techniques will empower the poor to voice their concerns and also avoid raising expectations. This will be discussed in Chapter 5.

5 CONSULTATION

5.1 Introduction

This chapter describes the consultation process that is part of community participation and should always be included in the planning and implementation of Urban Safety Management (USM) schemes. Note that monitoring and evaluation, which are also important elements of any scheme and can be considered as part of the overall participation process, are covered separately in Chapter 6.

Consultation is much more than just talking to people to find out what they think. It should ensure community participation throughout the whole process and is especially valuable to support non-engineering components of USM. Conducted properly it can be used both to improve the design of a scheme and facilitate its implementation; it can reduce (or remove) opposition; and, importantly, it can assimilate local knowledge and experiences. While it does involve talking (although with an emphasis on listening) it is important that those consulted are the right people, the correct things are being discussed, and that it is done at the right time (Mikkelsen, 1995). If measures are being planned that are likely to bring about a change in people's lives - including the implementation of an USM scheme - their wishes should be part of the process and their opinions taken into account. In many cases this democratic exchange of ideas and interaction between the planner and public is becoming increasingly appreciated by both sides, and in certain circumstances there is legislation requiring it.

The benefits of using consultation to identify and share issues are even more important when the different parties involved may not have common values, or even share the same vocabulary. This can be the case when central government decides to impose improvements on communities - and perhaps even more so if experts (whether international or local) think they know the critical issues and how best people's lives can be improved.

This chapter considers a number of frequently asked questions about the consultation process and attempts to provide answers to support its use as well as providing guidance on how it should be done. The various issues covered are listed in Box 5-1.

Box 5-1 Issues covered relating to consultation process.

- Why consult?
- Who to consult?
- When to consult?
- What to consult on?
- How to consult?
- How to analyse? and,
- How to resolve conflicts of interest?

5.2 Why consult?

Any change process will normally benefit from consulting those involved - provided that it is done in a sympathetic, timely and honest way. This holds true whether the change concerns an individual, an organisation or a community; and is especially true when there are plans that will markedly alter the way people lead their lives. This means that transport schemes,

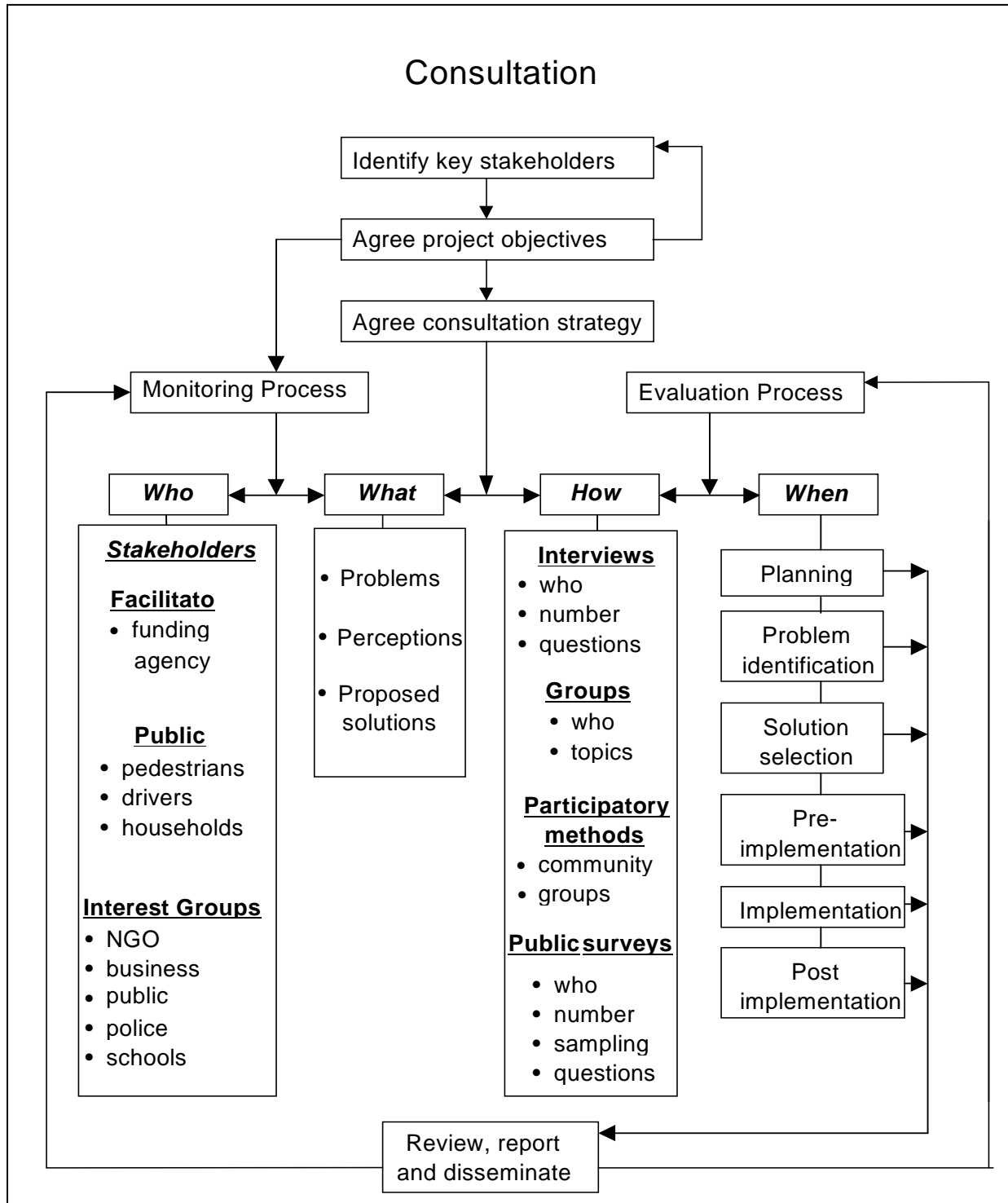

Figure 5-1: The consultation process

One of the underlying strengths of the USM approach is that it represents a systematic approach to road accident prevention, and casualty reduction, by bringing together a variety of disciplines and views to create an integrated strategy. This considers safety, traffic management, education, enforcement and transport policies under the same 'umbrella'. However, this approach can only be successful if the views and opinions of everyone (from the public to politicians) are obtained and taken into account. This democratic approach

differs from the historic approach of knowing what is best and imposing changes on an unsuspecting, and ignored, public, and other affected organisations (such as bus companies, the emergency services and traffic police) that may find the proposals ill-conceived.

The consultation process can add value to a wide variety of schemes for a number of reasons. One key reason is that the consultation process is likely to promote local awareness and ownership of the project and encourage stakeholder participation in achieving the objectives. This will mean that there is a much higher likelihood that the project will be successfully introduced and that its effect will be sustained over time. Another reason (and one that is often underestimated) is that consulting makes local knowledge and experience available. Feedback such as "we've tried that and it didn't work" or "you won't manage to do anything around here unless you involve..." provides useful information that can be catered for if it is known at an early stage of the process; rather than later, when it might already be too late to incorporate changes into the plans. Also, in many cases, consultation in one form or another is a statutory requirement; and is thus likely to become more important as its value becomes more widely appreciated.

5.3 Who to consult?

5.3.1 Introduction

The USM approach is based upon bringing together a wide range of different issues. The consultation process may thus need to consider a wide range of factors such as: safety, enforcement, traffic management, public transport, transport planning, area-wide or local engineering treatments, road construction and maintenance, land use and development; as well as things such as environmental, health and education issues.

The consultation should involve the public, key stakeholder organisations, as well as other interest groups; although it should be expected at the outset that these various groups may have very different opinions. Indeed, other groups are made up of very different factions so that even various members of the same group will have conflicting interests and views.

The need to consult widely raises the question of who are the public and who are the individuals or organisations whose support, or opposition, needs to be taken into consideration. In some instances individuals may be in more than one group and may vary their opinions depending on the group under which they are currently being consulted.

5.3.2 The public

The public are made up of a large number of disparate groups each having their own particular interests and concerns. They may be male or female; and young or old. Similarly, they may be consulted as an individual, as a parent, or as a house-owner or simply the member of a household. Similarly, when dealing with transport and traffic issues, they may be sampled because they are pedestrians, cyclists, bus passengers, or drivers - while at different times they could be each of these. Alternatively they will be asked to contribute because they are involved with a business in some way. Equally important is to identify whether they work or live (or both) in the area being considered. What might be considered good for businesses may not be as welcome to residents. Similarly, different people have very different financial circumstances and what may be popular with the rich may not be as appealing to the poor, and vice versa. Public consultations normally target a sample of one or more groups depending on what particular scheme is being planned. An attempt should be made to consult with all members of the public who are likely to be influenced by the scheme, particularly with the poor as they are often not as effective at voicing their opinions.

These issues raise the question of how to sample those people whose views are being canvassed. Also as well as who, it is necessary to consider the question of when and where the sample is approached. Pedestrians in a city centre when people are going to work are likely to hold different views to those sampled late at night or in a more suburban area. Similarly, house visits during the day will provide responses from different members of households than if done solely in the evening (see section 5.6.3).

However, whatever method of contact is actually used, there will also be individuals refusing to take part (eg "I'm in a hurry", "I'm not from round here"). The percentage of such refusals should be recorded in order to retain confidence in the accuracy of the results. If it is too high the sampling method may need to be reviewed.

5.3.3 Stakeholders and other ('interest') groups

The term 'stakeholders' is normally given to organisations (or occasionally individuals) who have an interest or may be affected by the scheme being proposed; and includes those organisations with the responsibility for funding and carrying out the implementation. Again there are problems with identifying which particular stakeholders should be consulted. In many cases there may be more problems with arranging appointments with the key individuals, or even identifying which person(s) within a particular organisation should be involved. In many schemes a small group of key stakeholders may form a committee (or similar group) which will meet on a regular basis to assess progress and 'consult' each other. In most instances there will be a variety of other organisations who will have an interest (often vested) in the project being proposed. While some will be supportive of the project, there are also likely to be a number of others who will be against it.

In USM projects the key stakeholders normally represent organisations such as:

- National Government (who may be providing funds)
- Local Government (who may be responsible for implementation)
- Various Local Government Departments, eg: -
 - Highways
 - Transport
 - Traffic
 - Engineering
 - Environment.

In addition to such key stakeholders there is a need to take account of other groups who may have an interest. Such interest groups need to be consulted in an attempt to both strengthen support and reduce negative opposition. Who such groups are will depend on the nature of the proposal and the local way of life and culture. Such organisations might include:

- The traffic police
- Public Transport Companies
 - Buses
 - Taxis
- Transport Companies (eg Lorry companies)
- Commerce and Industry
- Health
- Education
- Emergency services (eg police, fire and ambulance)
- Local NGOs, eg those concerned with:

- Heath
- Education
- Road safety
- Environment
- Community Groups, eg:
 - Residents Associations
 - Street Vendor Associations
 - Mothers/parents/religious groups.

The above lists are only indicative of the sorts of organisations that might be usefully consulted. In practice it will be necessary to take account of the particular circumstances in each country (or state, town, village etc) and the nature and scope of scheme being planned. In practice there is no fixed list defining those organisations or individuals that need to be involved. It is recommended that individuals being consulted are invited to suggest other key contacts that they think should be involved. Ultimately the size of this process will be dependent on the time available and the budget provided.

5.3.4 Inclusion of the absolute poor

Clearly, the most vulnerable groups in high density areas are at most risk from injuries caused by road traffic. This group is by no means homogeneous, but includes the homeless, unemployed, women, children, elderly and infirm; all those who have a propensity to walk for their respective travel needs because they have little or no access to transport services or private transport means. It is these demographic groups who should be targeted specifically for USM consultations, because, as this chapter has described, pedestrians are 'captive' and constitute the largest proportion of fatalities associated with RTA's, and because they are the least likely to articulate their needs and constraints.

Gender related disadvantage is endemic (refer to Box 5-2 for a case study of women in Dhaka). Many activities typically undertaken by women (child-care, household management, informal sector employment, etc) require them to make more and shorter trips than men, more trips at off-peak hours and off the main routes, and engage in more complicated multi-leg trips, all of which tend to make their movements relatively expensive to provide for by public transport, and hence highly priced or poorly supplied. Women are very vulnerable to these cost characteristics as they frequently have less capacity to pay than male household members, who also control any bicycles or other vehicles available to the household. Cultural factors may constrain women's ability to use public transport or bicycles. In many countries there is also a problem of the 'social safety or security' of public transport for women, especially in the evening hours. This may force them to depend on more expensive alternatives. Peripheral location may be particularly damaging to women's employment potential (World Bank, 2001b).

Evidently, these most vulnerable groups require empowerment to speak out and make their own decisions relative to their daily transport needs and to ensure that USM works for them. Through building of local capacity, the urban poor can empower themselves to contribute to the process of USM, and to continue with local safety campaigns once the road safety infrastructure is in place, and intervening parties have vacated.

Box 5-2: Women's urban transport constraints in Dhaka

The population of the city of Dhaka has grown over the last decade, creating a massive demand for transport, which has not been matched with investment in infrastructure. While inadequate transport services impact all residents, women commuters face particular mobility constraints. Since *purdah* (seclusion of women from men) defines separate spaces for men and women and based on their different roles within the household and society, women have distinct transport needs. Their access to social and economic opportunities and mobility in public places are thus compromised by the lack of an effective transport system to meet their needs.

The current transport services provided by public and private buses are insecure, unreliable, congested and unsafe. It is difficult for women to compete with men for the limited space, particularly given the cultural background in Bangladesh, which has a restrictive attitude towards women's mobility. Bus operators are also less inclined to accommodate women's specific needs due to their focus on maximising returns.

Women's transport problems require particular attention, because their labour force participation and productivity is adversely affected and because it impairs women's access to education opportunities. For many, transportation costs are unaffordable, while for others the risks of sexual and verbal harassment are simply too high.

Source: Study on Gender Dimension in Dhaka Urban Transport Project (World Bank, 2001c)

5.3.5 Local media

Although not an essential part of the consultation process it is usually advisable to involve the local media in the process from the outset. Television, radio and newspapers can all be used to publicise the project (when the time is right), call for feedback from the community, and to promote the programme by outlining why it is being proposed and the advantages that are anticipated.

It should be appreciated that this particular type of 'consultation' will involve providing media stories or articles, so that it should be pitched at a lower level and will need a good ('positive' for the project) headline and avoid the use of overcomplicated scientific jargon.

5.4 When to consult?

It is generally recognised - and understood - that you should consult at all stages (see Figure 5-2). That is, it should be done: before, during and after. In fact the process should be continuous in that it should be prepared to respond (ie, listen, explain and incorporate) to any contacts initiated by others at any stage. This secondary (and continuous) process should be seen as a natural result of the primary proactive activities (eg surveys, interviews and media reports) initiated as part of the programme.

However, it is the earlier consultation that can be most valuable. For this reason they should start very early in the planning process and sufficient time and flexibility should be allowed to avoid having to make major changes towards the end of the programme.

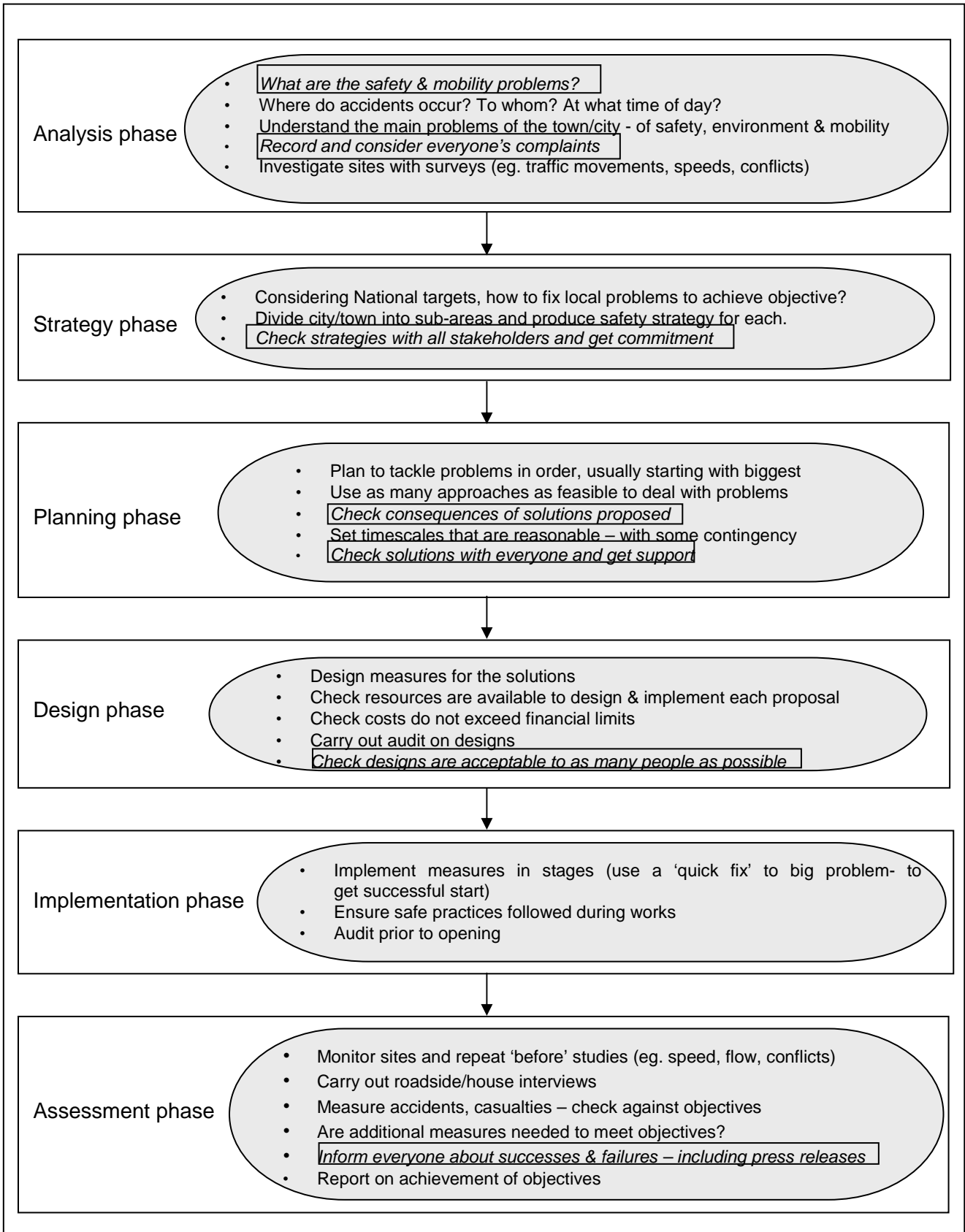

Figure 5-2 Stages of a USM project: items in italics can be part of consultation

It is strongly recommended that the consultation process is recognised as providing a valuable input into the early formative stages of any project. This means that the 'before' consultation process should be initiated (perhaps in a small way) when the schemes are first being planned. At this stage it may be more a case of examining the feasibility, the main issues that need to be considered and who should be consulted as part of the programme. When the proposals are more advanced and more detailed (but still 'before'), consultations should also be undertaken.

Consultations made 'during' the intervention should assess what problems are being encountered as it may still be feasible to make 'fine tuning' to the plans; and how things might have been done better (so that they can be avoided in the future).

Consultations conducted 'after' implementation can be viewed as part of the monitoring and evaluation process (see Chapter 8).

5.5 What to consult on?

5.5.1 Introduction

This question is often answered by suggesting "if in doubt consult". A more considered answer might be to consult if the process is considered likely to produce a better outcome; which may require the involvement of experienced practitioners - or at least talking with them if in doubt. This can result from improving the intervention at the initial design stage (see section 5.3.3) but its equal importance is to serve to reduce problems during the implementation that ensue, say, from a powerful opposing ('Why wasn't I informed?') faction.

The answer here also depends on the nature of the project, what stage it has reached and who is being consulted. The key issue is to remember that the consultation is being done to support and improve the overall project - not to placate individual pressure groups or respond to individual companies vested interests. Note that sections 5.2 - 5.5.5 use a different (updated) terminology to that used earlier when considering the various stages of USM projects (see Figure 5-1 and Figure 5-2).

5.5.2 The analysis (problem identification) and strategy phases

The kinds of issues that need to be considered here are:

- Are there any implications (other than safety and mobility/congestion) that need to be considered?
- What are the main transport problems and issues that need to be addressed?
- Who needs to be involved and consulted?
- Where do the accidents occur, to whom, when... and why?
- What are the main problems
- What would be the best solutions? and
- Listen to everyone's suggestions and concerns.

5.5.3 The planning and design phases

This phase provides the opportunity to obtain feedback about the sorts of measures being proposed and should obtain information on:

- Which of the proposed measures they like?
- Which measures they dislike (or think won't work)?
- What is wrong with proposals?

- What is right with the proposals?
- Are they likely to get community support?
- What are the likely problems that will arise with actual implementation?

This phase also provides the opportunity to 'revisit' some of the issues examined in the first phase and provide more detailed information if required. It should produce information to enable tailoring of the designs to be acceptable to as many people as possible.

5.5.4 Implementation phase

Chapter 7 considers the final design and implementation phase in detail. During the actual implementation of the measures the opportunity exists to see what unforeseen problems might be caused to motorists and other community members by the implementation. In some circumstances it may be possible to rectify these immediately (or quickly during the consultation process); in other cases it will simply provide guidance to avoid the same problems being encountered in future similar projects.

Problems likely to be encountered because of temporary 'nuisance' factors (such as congestion, noise, dust) can often be reduced by warning people in advance using the media (eg local papers) or by displaying advance 'warning (and apology)' signs. This is one reason for involving the media from an early stage.

During this stage it may be necessary to explain that the scheme's long-term benefits will only become apparent after the implementation has been finished - again a possible media story.

5.5.5 Assessment phase

Monitoring and evaluation of schemes is important to assess effectiveness and 'learn lessons' for future schemes and avoid repeating mistakes. A proper consultation evaluation of the scheme can only be attempted after it has been in place for some time. Often as long as six months are required for people and traffic to adapt, although evaluations based on measures such as accident data can take considerably longer.

A public evaluation, using surveys, after (say) six months is often a good idea for two reasons:

- Firstly, it can provide an early success story ('aired' in the media), which can serve to reinforce public support
- Secondly, it can be used to identify any significant 'teething problems' that may need to be rectified in the short term

The question of how to go about assessing or evaluating projects is dealt with in detail in chapter 8.

The scope of any consultation depends critically on the type of intervention that is being considered. Thus engineering projects may involve a wider consultation than if simply increased police enforcement is planned; although in both cases a sensible budget needs to be set aside for the activity. Figure 5-2 shows the various stages of implementation of an USM project in developed countries (after Lines, 1995); those items in *italics* indicate what elements of the project should (or could) involve consultation.

Additionally there are a wide variety of issues that need to be taken into account (by means of consultation) when developing any USM scheme; and these may go beyond the normal safety and traffic considerations. Some of these might include:

The location and requirements of:

- Markets and shops
- Hospitals and health clinics
- Primary and secondary schools
- Commercial and industrial enterprises
- Banks
- Water supplies (in developing countries only).

A number of wider transport issues might also be considered, such as:

- Religious/culture issues
- Road network considerations
- Construction and maintenance
- Vehicle ownership (both current and future)
- Transport industry interests.

5.6 How to consult?

5.6.1 Introduction

The consultation process can use a variety of different methods; and any individual consultation can involve a number of such methods. The methods most normally used involve:

- carrying out public surveys
- conducting interviews with representatives of stakeholder and interest groups
- holding focus group discussions
- organising meetings and exhibitions
- using participatory methods.

The first method results in *quantitative* information (eg "One-third of drivers support...") while the second two result in *qualitative* information ("Those organisations involved in transporting goods and people think..."). Meetings and exhibitions can result in a variety of types of information, such as votes, signatures on petitions and expressions of support or concern from individuals. The use of participatory methods can also provide a variety of types of information.

Each of these general methods can be conducted in a number of ways. For example, surveys can be conducted at the road-side, by telephone or by post. While individual interviews can be conducted using questions that are either 'open' (eg "Why do you think...?") or 'closed' (eg "Do you think it would be good or bad to...?").

5.6.2 Review of literature and previous experience

It is often not appreciated that an important part of the consultation process can involve conducting an initial review of relevant research literature and publications. Indeed such a stage may influence - for the better - how the subsequent 'live' consultation is planned and conducted.

Similarly, it may be worthwhile to seek out advice from experienced practitioners who may not have had the opportunity to commit their 'wisdom' to writing. It is unfortunate that many road safety schemes (even those that have been properly evaluated and positive results obtained) go unreported leaving other authorities to make similar mistakes. Unfortunately, this is especially true in developing countries.

5.6.3 Conducting surveys

The most frequently used method of conducting a public consultation is to conduct surveys. However, in order to provide useful information they have to be designed, conducted and interpreted correctly.

It is necessary to have a clear idea of who makes up the 'public' and which of them are of particular interest. In USM schemes it is normally advisable to collect a variety of road users' information from, for example:

- Males and females
- The young (either children, eg under 15, or youths eg 16 - 20 year olds) and 'older' persons
- Whether they live and /or work in the area
- If they are drivers/riders, what type of vehicle do they drive (eg car, bus, lorry, non-motorised, etc)

It is useful to know

- whether they are working or at leisure (If interviewed on the street) and
- what is (or was) their reason for visiting the area.

Members of the public (or road users) can be sampled by:

- stopping them at the roadside
- house calls
- via the postal service, or
- contacting them by phone.

In developing countries the first two methods of the above interview types would normally be the most appropriate. If house calls are made, it is important to do this at the appropriate time of day. The use of postal surveys (popular in developed countries) is likely to produce a low response rate and a distorted sample - unless the wish was to contact public spirited, literate house owners! The use of phone surveys which are becoming increasingly popular in developed countries (because they are cheap and are justified because most people have telephones in their homes) but thus should not be used in developed countries unless the restrictions it imposes on the sampling are recognised.

The usual aim when designing a sampling method for a survey is to obtain a 'representative' sample, ie. the small sample contacted is as similar as possible to all the members (the population) of that group. An example of a group might be: children under the age of 15, males with a full driving licence, drivers prosecuted for speeding, etc.

If normative (ie. population) information is known about the group of interest (such as their age and sex) the target can be to obtain a 'quota' sample, such that the age and sex proportions within the sample matches (or approaches) that of the population.

If this information is not available (and not being collected as part of the study) a representative sample can be obtained by selecting, say, every 7th pedestrian (at a particular point on the footpath), truck driver (stopping at a particular rest spot) or business (along a road). This sampling technique is more popular than using the quota method because of problems associated with finding the last few individuals in the designated quota.

Questionnaire surveys can be used to collect various information and can use a number of types of questions:

- Demographic questions are used to find out about the respondent's age, sex, marital and working status, etc. (If the interview is conducted at the roadside it is unnecessary and

inadvisable to ask what sex the person is). This data is normally coded into bands (eg aged 20 - 29) or into predetermined categories.

- Some (closed) questions simply ask for 'yes' or 'no' responses; in some cases 'don't know' or 'not answered' replies are permitted. These questions normally take the form of:
 - Would you be in favour of...?
 - Should there be more...?
 - Have you ever...?
- Some questions involve rating scales that obtain information on how strongly the belief or attitude is held. Such questions typically have bipolar scales (eg good - bad, in favour - against, often - seldom, strongly - weakly, etc) with the end points of the scale divided into a small number of points. A typical scale might be : Very good (1), Good (2), Neither good or bad (3), Bad (4), Very bad (5), and possibly with a don't know (6) permitted.
- Some questions require the respondent to choose from a sample of predetermined categories. For example they might be asked 'How frequently do you shop in this area? The range of answers provided might be:
 - (1) Never,
 - (2) 1 - 2 times a week
 - (3) 3 - 4 times a week
 - (4) 5 - 6 times a week
 - (5) more than 6 times a week

Some (open) questions simply request answers without providing any response format. Here the response is written down and coded (into response categories) before any analysis is attempted. Because of this additional effort the use of such questions is kept to a minimum - but can be used to provide information about issues where the researcher lacks prior information about how interviewees will respond (eg What could be done to improve road safety in this area?)

5.6.4 In-depth (or semi-structured) interviews

In addition to interviewing households to establish travel patterns and income data, qualitative research methods are essential to determine the nature and scale of the traffic problems in the study area. Stakeholder analysis provides all who have an interest or are affected by the USM process to express their views. They may be positively or negatively affected (winners or losers) and may be either involved or excluded from the decision-making exercise. Stakeholder analysis aids researchers to assess a project by identifying the interests, conflicts and relationships of the various stakeholders. By tabulating data on each of the stakeholders, the importance and the priority of each stakeholder in the project can be assessed. This method assumes a primary stakeholder is ultimately affected by the measures, whilst a secondary stakeholder is an intermediary in the USM approach or may be indirectly affected.

Some key points for designing a semi-structured interview questionnaire given by Michelson (1995) are listed in Box 5-3.

Box 5-3 Designing a semi-structured-interview

- It is deliberately not presented as a script where questions are read out and answers given.
- It is designed so that the answers can be easily coded. However, the interviewers are not expected to code the answers as this is likely to interrupt the flow of the interview.
- The questionnaire should be easy for the interviewees to respond to. An emphasis on pictures should be given, eg weights should be given in terms of bags and bunches etc.. This can then be translated into kilogrammes later.
- Distances between key places will be needed – sometimes it is easier to describe this in terms of time or in relation to other places.

(after Mikkelsen, 1995)

5.6.5 Focus groups

An intermediate technique - that could be used with either the public or stakeholders - is to use small (focus) groups of individuals (typically between 5 and 9 in number) and a 'facilitator' who leads the group in open discussions about topics; typically raised by the facilitator; although sometimes identified by the group itself.

5.6.6 Meeting and exhibitions

Another way of 'consulting' the public is to hold public meetings or exhibitions. These are only effective if they are explained and advertised widely - and even then they might be poorly attended. Those who attend are usually individuals who are better informed and socially active/interested. While this method is popular in developed countries (in addition to or in the place of other types of 'survey') their use in developing countries has been limited often because of problems with informing people, providing a suitable location and finding a suitable time when the majority of people are free to attend.

5.6.7 Consulting the community (Participatory Learning and Action)

In addition to these methods (which are all used regularly in developed countries) there is the 'participatory learning and action' method that is now widely practised (especially in developing countries) in order to understand the concerns (and problems) of the rural poor. In essence this is a focus group (discussion) type of approach where the group might be an entire village and time is devoted to making sure that issues (and a vocabulary) come from the group rather than the researcher. This approach is especially important when adopting a bottom-up (rather than top-down) approach.

'Participatory learning and action' (PLA) is the most widely used name for methods developed to consult communities. Another method is 'Rapid rural appraisal' (RRA) but because PLA is becoming increasingly popular in developing countries and communities, it will be described here. A more detailed description is available elsewhere (eg. Mikkelsen, 1995).

In many consultation exercises there is a need to collect bias free data from 'local' groups and individuals; and to collect it using quick and efficient (and thus economical) methods. The PLA approach has been developed to ensure that the information obtained accurately describes the desires and wishes of the community (bottom-up), and enables policy makers to have a better understanding of the dynamics of poverty, regional characteristics and coping mechanisms used by the poor. It involves the policy maker in listening to and including women, the poor and vulnerable in the decision-making exercise.

The analysis method's name derives from "*Participatory*" referring to the need to include the 'stakeholders', i.e. those people primarily involved (persons, groups or institutions in a project or program - note that this use of the word is more inclusive than that considered earlier which tended to refer to 'important' individuals). The method was originally known as

'participatory rural appraisal' (PRA) since the techniques developed through rural development work; however the methodologies can be now applied equally to the urban poor.

The PLA approach draws on a range of methods including informal surveys, participant observations, community meetings, focus groups, and in-depth interviews. It is proving to be increasingly popular because it is generally cheaper and quicker than traditional survey techniques; however, if it is not carried out correctly by skilled practitioners the results can be misleading. However, PLA is generally much better than, for example, a free-standing household survey because it is multi-stranded, consisting of integrated components and combining many different research methods. The methods are flexible not rigid, visual not verbal, based on group analysis not individual, and involve comparing not measuring (Mikkelsen, 1995). Many of the techniques used in PLA are based on discussions with households. Boxes 5-4 and 5-5 provide summary information on PTA methodologies and conducting household interviews.

Box 5-4: Outline of established PLA methodologies

- Find and critically review secondary data
- Observe directly: see for yourself
- Seek those who are experts about specific issues
- Key probes: questions that can lead directly to key issues base on the assumption that local people are doing something (i.e. what happens when someone's house burns down?)
- Case studies and stories: a household history and profile
- Groups (casual or random, representative or structured for diversity, community or neighbourhood, formal or informal): Group interviews are often powerful and efficient, but relatively neglected, perhaps due to continued focus on individual questionnaire based interviews.
- Do-it-yourself: Local people teach the outsiders how they live their lives.
- Mapping and modelling: these methods have been one of the most widely used and can be combined with well-being ranking, household listing, transects, and linking diagrams.
- Local analysis of secondary sources: Participatory analysis of aerial photographs etc...
- Transect walks: systematically walking with key informants though an area, observing, asking, listening, discussing, learning about different zones, local technologies, seeking problems, solutions, opportunities, and mapping and/or diagramming resources and findings. Transects take many forms: vertical, loop, along a water course.
- Timelines and trend and change analysis: Chronologies events, listing major local events with approximate dates; peoples accounts of the past, of how customs, practices and things close to them have changed.
- Seasonal Calendar: Distribution of days rain, diet, food consumption, sickness, migration, income etc...
- Daily time analysis: Indicating relative amounts of time, degrees of drudgery etc.
- Institutional or Venn diagramming: Identifying individuals and institutions important in and for a community or group, or within an organisation and their relationships.
- Linkage diagrams: of flows, connections and causality.
- Wellbeing grouping (or wealth ranking): grouping and ranking households according to local criteria, including those considered poorest and worst off. A good lead into discussions of livelihoods of the poor and how they cope.
- Team contracts and interactions: Contracts drawn up by teams with agreed norms of behaviour; modes of interaction within teams, including changing pairs, evening discussion, mutual criticism and help; how to behave in the field etc.
- Shared presentations and analysis: Where maps and models, diagrams and findings are presented by local people and/or outsiders, especially at community meetings and checked corrected and discussed. Brainstorming, especially joint sessions with local people. But who talks, and how much, who dominates etc.
- Contrast comparisons: Asking group A to analyse group B and vice-versa. This has been used for gender awareness, asking men to analyse how women spent their time.
- Drama and participatory video making on key issues: to draw together problems and explore solutions.

- after Chambers and Guit. 1995

Box 5-5: Household interviews as part of PRA methodologies

Defining a household in developing countries can be a problem, the recommended definition is: "A group of people who live in very close proximity to each other, who eat together, and who share responsibility for the income and expenses of the group". The household members will not necessarily live in a single dwelling, but will, for the most part, be related. It will generally not be necessary to collect data for children who are away at college.

Defining a child and an adult can also be problematic. This is best defined based on the role of the person in the household. A child who is at school can only make a limited contribution to the household activities. However a person who has left school can make a much greater contribution. Therefore the most useful definition between child and adult is the age the child leaves school. E.g. if primary school education is universal but only a minority of young people go to secondary school then the boundary should be based on primary school leaving age; if the majority of young people complete two or four forms of secondary school then this defines the boundary.

The purpose of a household interview survey is to obtain data on travel patterns (and involvement in road accidents). This is the most time consuming of all the data collection techniques. Survey resources are likely to be limited therefore it is useful to identify means by which the input to the household interview element can be minimised. The questionnaire should be designed so that it can be administered by enumerators at the university student, intelligent high school graduate or junior official level. It is desirable that the enumerators speak the local language. However it is important that the enumerators do not live in the study area.

Survey methodology is based on surveying 10 per cent of the population of a study area. It should be possible for a good enumerator to conduct four interviews per day. A minimum of 15 households is recommended.

Participatory methods have contributed to adjusting the interview to make it more conversational, whilst still structured. Many questions will be formulated during the interview – at a later date irrelevant questions can be dropped. Questions are asked according to a flexible checklist or guide and not a formal questionnaire.

Semi-Structured Interviews (SSI) should be used along side other exploratory and participatory techniques e.g. observation, ranking and mapping.

Mikkelsen. (1995)

5.7 How do you analyse the findings?

Development of the urban safety strategy involves assimilation of all the data collected and evaluation in both a quantitative and qualitative manner. Interpretation of the data is simplified if the information is cross-referenced graphically and numerically for the accidents with respect to the functions of the roads in the local area. In particular the assessment should try to determine the performance of a road relative to its intended function. Roads with multiple functions are more likely to lead to accidents by presenting an unclear definition of its function to the road user.

It is likely that the data will suggest several different means of remedying a specific problem therefore once the most appropriate option has been selected all the schemes should be prioritised and resources assigned accordingly. Public reaction to the schemes should be sought and the views taken on board to ensure that there is consensus amongst the local stakeholders and a general feeling of involvement.

While quantitative information can be analysed using objective statistical techniques (especially if changes or differences are being examined), qualitative information is much more problematic - although a variety of methods can be used to reduce the subjective element of any analysis. One such method is 'content analysis' which examines the words and structure of spoken or written language to understand the underlying meaning being conveyed. It can, for example, compare the frequency of use of 'positive' or 'negative' words to reflect attitudes and opinions and how these may have changed over time (see Denzin and Lincoln, 1994).

5.8 Resolving conflicts

Any properly designed consultation will identify contrasting or conflicting points of view. If this is not the case it is likely that an inadequate sample have been asked inappropriate questions. The resolution of such conflicts remains as one of the main difficulties of the consultation process. Chapter 6 deals with the problem of 'decision making' for solution.

Methods for assessing the before and after scheme implementation situation may be defined as either qualitative (softer, more subjective approach, often open to individual interpretation), or quantitative (objectively measurable).

5.9 Summary guidelines on consultation

- Start early
- Spend time identifying the right groups and organisations
- Do more listening than talking
- Consider recording interviews (so they can be analysed at leisure)
- Use the consultation process to direct subsequent phases (of consultation and USM programme)
- The 'bottom-up' focus should be far more important than the 'top-down' strategy
- It should be transparent and findings made public
- 'Make friends' with (and use) the media

6 DECISION-MAKING FOR SOLUTIONS

Chapters 3, 4 and 5 have described the data collection phase of USM to enable the main problems of a town or city to be identified and understood. The first part of this chapter discusses the steps necessary to understand the problems in more depth and to develop a strategy for tackling them, and then plan the countermeasures. In selecting and planning the countermeasures, it is necessary to be aware of the full range of possible solutions available; therefore, in the second section of this chapter, a wide range of examples of solutions are provided under the main categories of:

Engineering and Planning

- improving road user behaviour;
- provision of facilities for road users; and
- minimising crash severity.

Education

- Road safety education in schools
- Training
- Road safety publicity

Enforcement

6.1 Re-appraising the Network

6.1.1 Introduction

This particular section outlines how the various data sources and survey analyses are merged to reach decisions about what is needed to be implemented and what is feasible. However, it must be remembered that this process cannot easily be standardised as every urban area is unique, having different combinations of problems.

6.1.2 Analysis phase

As indicated in Chapter 2, the Problem Analysis phase of USM involves two main areas of data collection and analysis:

1. Engineering related data, to get a quantified picture of the current highway and traffic situation over the study area; and
2. Available accident and other sources of data, to assess the safety of the network as it is currently operating.

In reviewing the current road safety situation in the city, the national casualty reduction target and strategy must be taken into consideration.

With the standard accident analysis process, accident data or surrogate safety information for the city is analysed under various headings such as:-

- by road user type
- by road type
- by accident type
- by time of day
- by vehicle type
- by road condition

This allows for common types of accident to be identified at a macro level, and measures designed to affect and reduce them. It is often useful to look at all motor vehicle casualties

on the various road categories and consider pedestrian casualties and two-wheeler casualties separately.

For example, if a high proportion of casualties comprise pedestrians and this accident type is clustered at junctions, then this would suggest that vehicle speeds are too high to cope with the conflict of road user movements, and there may well be a lack of crossing facilities. This would require more in-depth analysis at individual junctions, but might suggest an installation programme of marked crossings, speed reducing devices, and pedestrian barriers.

Once common accident groups or 'accident cluster' sites have been dealt with by appropriate countermeasures, there is then a more scattered distribution of accidents over the network which needs to be treated by an area-wide approach. Dividing the city into areas bounded by barriers such as railway lines, rivers etc may be useful at this stage. The analysis should show which areas have the highest accident rates where measures might be installed first.

6.1.3 Establishing or modifying the road hierarchy

Traffic flows also need to be taken into consideration, and will have been studied in detail to establish the ideal **road hierarchy**, as discussed in Chapter 2. In many cities, arterial or main roads may also serve other functions and the engineer should try to balance very carefully the need to carry heavy vehicle flows whilst catering for vulnerable road users who are currently at great risk.

Although most roads serve many purposes, it is important to identify how the local network can most appropriately perform the functions required by the area. There may well be discrepancies between the engineering road hierarchy and the functional road hierarchy, but the starting point is to identify the functions currently being performed by each road. In many cases, it will be found that a road cannot be assigned a single primary function, and it is often this diversity of activity that has led to a higher accident history. This can possibly be because of an initial unclear definition of function or because the road has just been allowed to develop haphazardly without any form of control.

It is important for engineers to recognise that roads are not just arteries for movement but are used as public urban spaces as well, and this needs to be taken into account when assessing and adapting their functions. Although a relatively comprehensive list of possible categories of urban road were described in Chapter 2 (ie. Primary Distributors, District Distributors, Local Distributors, Access roads, Pedestrian Streets), for most practical purposes only three levels need normally be considered:-

- Main roads
- Local distributors
- Access roads

Main roads also often form natural boundaries between residential areas and sever communities. It is not usually appropriate to include these main roads in one local area improvement since changes made to the main road to benefit the area might severely impact on an adjoining area. Thus main roads are usually best dealt with in isolation as a route length improvement but with a full assessment of the likely impact on adjacent areas. Comparison between the ideal and existing flows should identify roads which have inappropriate levels of flow. Reducing these flows is often a major part of the USM strategy, and this has tended to be the focus in developed countries. Indeed, safety can normally be improved at the expense of mobility. However, it is often the case that flows need to be kept at existing levels in most developing country towns and cities. Thus the challenge for

engineers and planners is to devise measures that will achieve reduced accidents at the current (or even greater) flow levels.

It is sometimes the case that as traffic volumes become extremely high, traffic speeds drop to such an extent that casualty accidents are also reduced, although damage only accidents may increase greatly. In this situation, there is a danger that improved traffic management can lead to an increase in casualty accidents.

6.1.4 Assessment of roads within the hierarchy

Each road in the network needs to be examined in terms of its current function and its observed performance. Where part of a route is inadequate by virtue of the level of traffic, traffic mix, poor accident history or environmental quality, there are really only two options to consider:-

1. Alter its role by transferring all or some of its functions to other roads;
2. Retain its role, and introduce specific improvements to overcome the deficiencies

A flowchart for the approach for assessing the performance of roads within the network is illustrated in Figure 6-1. Having studied available geometric data and traffic data to determine the engineering road hierarchy of the network, the roads are then further considered in two ways dependent on whether they can be classified as access or any of the distributor types.

Speed data is also an important measure which will often need to be collected, particularly at the high accident rate sites. In many cases residential areas may benefit dramatically from traffic calming measures that would introduce 30km/h zones. The self-enforcing, speed-reducing devices that such zones would ideally require often need to be combined with engineering features that give priority to cyclists and pedestrians.

As described in Chapter 5, it is important to be aware of the opinions of local users of the road network, and questionnaire surveys are the obvious way of eliciting this information. This should establish their normal use of the network, their road safety fears, and ideas or opinions on ways of improving the situation.

Normally, although a change in hierarchy may well be considered necessary, in practice this will probably mean retaining most of the existing main roads and local distributors, because opportunities for replacing them will be limited.

6.1.5 Urban safety review

In attempting to improve safety within an urban network, the objective is to identify patterns of accidents, not necessarily at single point locations or lengths of single main roads but over a wider geographical area. As the engineer is not now necessarily focussing on accident clusters, much lower levels of risk may generally be under investigation and treatments are likely to combine a mixture of different measures. Also, justification for the treatment of an area will probably be wider than accident reduction alone.

The relatively low level of accidents at, say, any one junction or 100m stretch of road means that it is important to combine all major accident types that do occur and use them to influence the design of the package of measures that will be recommended.

It is very useful to produce accident maps for the road network so that an immediate visual impression of accident density can be gained, perhaps by type of collision. Ideally the map should also show vehicle and pedestrian flows. Nowadays most computerised accident systems can produce such maps (possibly linked to a geographical information system)

quickly and easily, and can also facilitate more in-depth analyses to be carried out directly from the on-screen map (see examples in Chapter 2). The data analysed should ideally cover a period of at least the past three years (and preferably 5 to 8 years) so that trends and variability can be studied, and any underlying pattern can become apparent.

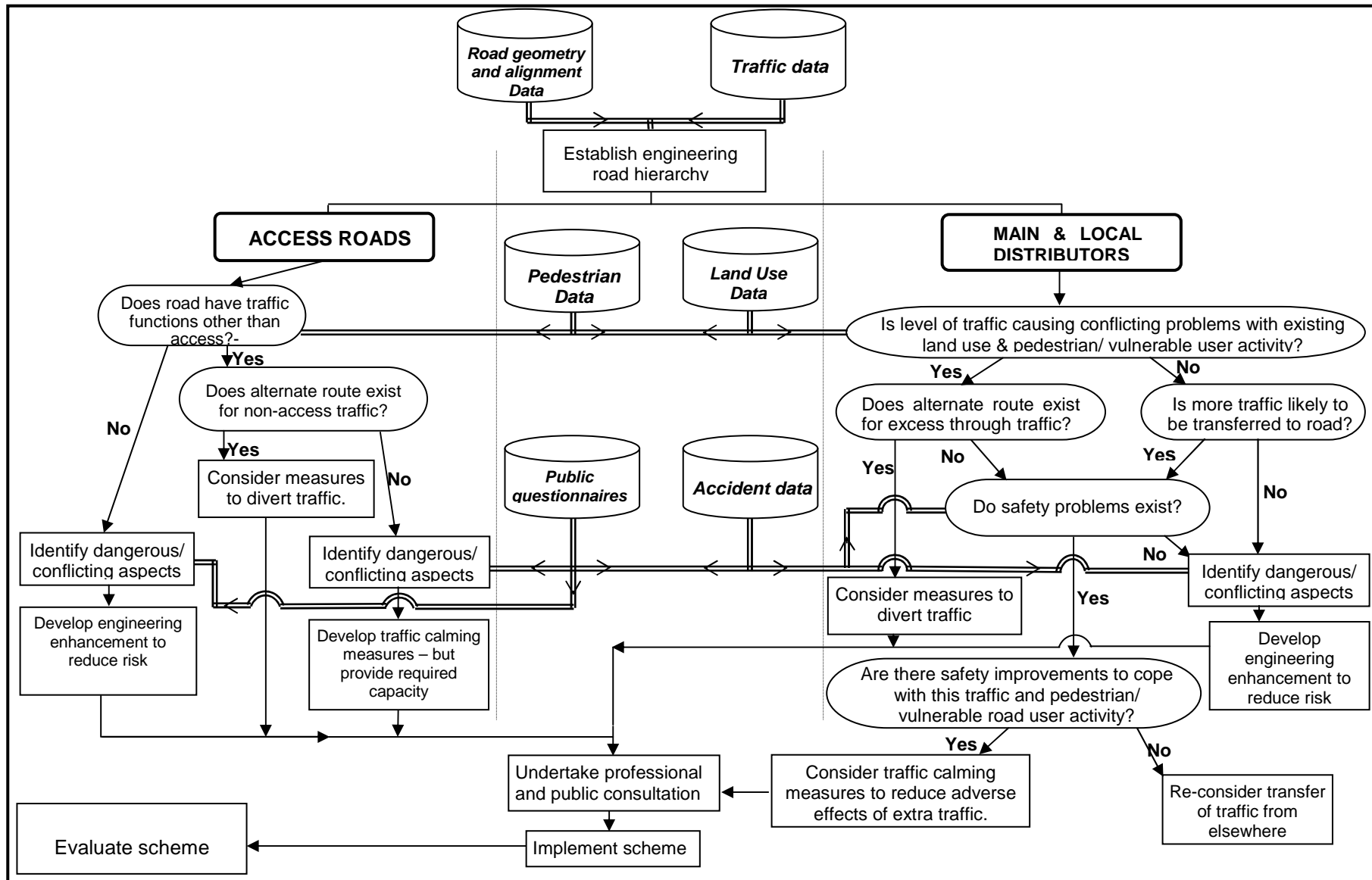

Figure 6-1 Flow chart of assessing change in traffic function and course of action.

The database can be used to study particular accident types, for example, collisions involving pedestrians by initially plotting just this one type of accident on the map to reveal specific accident cluster locations ('hotspots') for this group of road users. These can be investigated further to determine whether they perhaps involve a high proportion of school children or occur chiefly at certain times of the day.

It is, however, important to remember that reported accident numbers cannot be relied upon to give a complete indication of risk, particularly to vulnerable road users, simply because a large number of accidents go unreported to the police. For example, a recent study (Aeron-Thomas, 2000) using hospital records and police data in selected developing country cities found very wide variation in the levels of under-reporting, with estimates of police recording between 57 percent (in Harare) to only 3 per cent (in Hanoi) of the actual number of casualties. The matching of accidents involving children and women was generally poor, implying particularly low reporting rates for these road user groups. Similarly, a World Health Organisation study found that in the Philippines only about one out of five medically reported road deaths are included in police statistics (WHO, 1997).

Nevertheless the available accident database is obviously the starting point for determining where safety problems are concentrated and are likely to require more in-depth investigation, as outlined in Chapter 3.

6.2 The Strategy Phase

Having analysed accidents, land-use, road function, speed and flow data, public survey results and identified any special needs for the urban poor, this knowledge needs to be assimilated to formulate a strategy which may, in turn, need to be sub-divided into individual objectives for the areas into which the city has been divided. Targets for the area should be set which will be realistic (ie. achievable) and, taken together, match the overall or national target accident or casualty reduction.

6.2.1 Engineering and Planning Strategies

The aim of the programme of local area schemes will be to modify the road network in each part of the town in an affordable manner (which will in many cases inevitably mean a long timespan) that will achieve these overall objectives of safety whilst not inhibiting the movement of vehicles and people to any significant extent. Combining the knowledge gained from the various analyses, a set of qualitative objectives might be set for each section of major road or residential area, as illustrated in Figure 6-2.

Once blackspots have been treated, it will probably be found that most parts of the road network will not exhibit single dominant accident types for which there is obvious treatment. As stated in Section 6.1.2, accidents will tend to be scattered and may result from a combination of conflicting turning movements, speed differentials between motor vehicles and other traffic, pedestrians' need to cross roads, and arrangements for parking. One direct consequence of this is that the safety objectives will normally differ in nature between levels in the hierarchy:

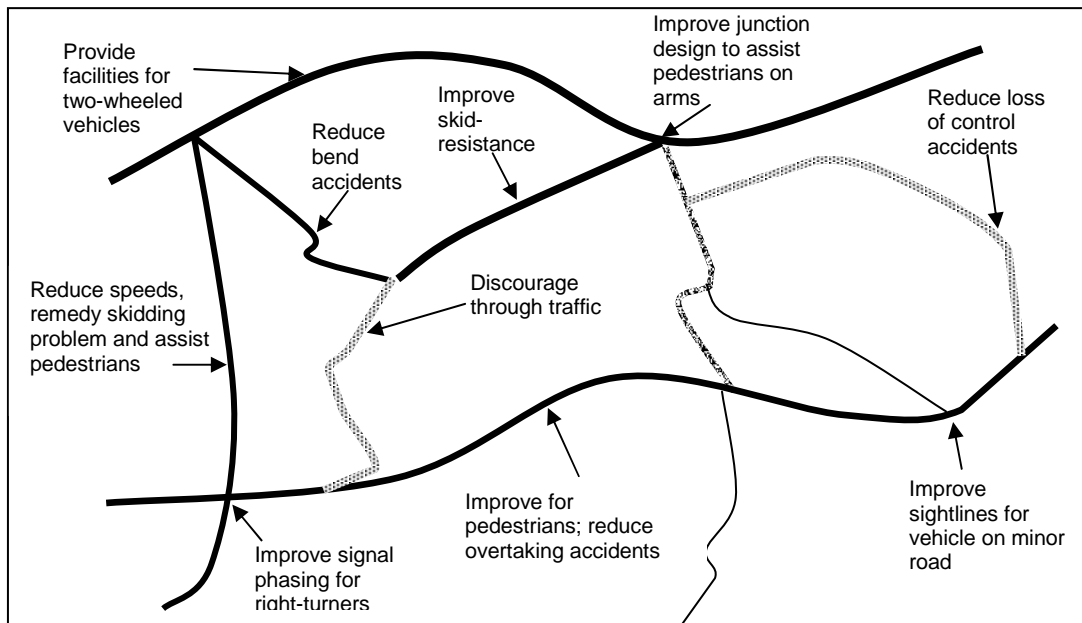

Figure 6-2 Typical objective setting for sections of a network

- **Main roads:** reduce right turns (driving on the left) and providing safer crossing points for pedestrians and cyclists; improve capacity to take vehicles away from local distributors; improve junctions
- **Local distributors:** reduce through traffic, reduce speeds, protect and control parking; provide safer crossings for cyclists and pedestrians;
- **Access roads:** minimise motor vehicle movement except for access; keep speeds low; where possible, link access roads to provide continuity

Whilst a tentative strategy should be drawn up by the study team, it should then be presented to a meeting of the stakeholders for discussion and amendment. One of the principle decisions will be to decide on any Local Area Schemes than have emerged from the analysis. A priority list for tackling the problems identified should be drawn up.

6.2.2 National and Local Education and Enforcement Policies

It might be thought that the possible scope for action in the areas of education and enforcement may be limited by national policies, but quite often existing policies allow a lot of flexibility and there can be large differences in how these are applied at a local level. However, some potential countermeasures that will be discussed, such as a driver penalty point system, may inevitably require a change in national policy, and therefore the action may be to put pressure on the national government for a change of policy.

One of the main objectives of USM is to develop a series of local schemes within a city-wide strategy. In implementing these local schemes, it will generally be necessary to run publicity campaigns to inform and educate the local road users about the design and purpose of the scheme. Also, it will generally be necessary to develop an enforcement strategy with the local traffic police. Thus, as with engineering and planning, education and enforcement are involved in USM at both the city-wide strategic level and the local level.

6.2.3 Education strategies

In most education systems, there are several distinct stages. Commonly, children start 'primary' school at age five or six and attend until the age of eleven or twelve. This might be followed by five or six years of intermediate and secondary education. Then, typically, students go on to universities and colleges.

During this process, the Department of Education may or may not include a significant amount of road safety in the national curriculum. It may be included as a subject in its own right or as part of a more general topic, using 'carrier' subjects, such as 'Social Activities'.

The curriculum can be presented in student workbooks (normally provided free to the children) that contains individual lesson materials. The workbooks for primary children should contain a lot of illustrations, and the illustrations should reflect the traffic conditions found in the city or urban area where the children live. They should avoid material not appropriate for young children (e.g. traffic signs and traffic signal sequences). The lessons should minimise didactic ('talk and chalk') teaching methods and should encourage 'self discovery' learning (e.g. on momentum or slipperiness) in a safe environment. The lessons should also include some direct roadside training.

6.2.4 Enforcement Strategies

The responsibility for road policing enforcement normally rests with the traffic police. The main activities of the traffic police usually involve both traffic law enforcement and accident investigation in addition to policing special events. It is recommended that:

- There should be an overall road policing strategic plan
- This should be based upon analyses of accident statistics
- There should be detailed local traffic policing plans.
- These local policing plans should include what actions/tactics officers should be undertaking when they were not responding to incidents or accidents.
- Operationally, the traffic police should be proactive as well as reactive.
- There should be a dedicated speed enforcement unit to ensure a consistent approach to enforcement
- Regular planned road safety enforcement campaigns should be conducted.
- Formal pre-and-post evaluation of strategies is also essential.

Proactive policing might involve deploying officers to various locations to undertake specific enforcement duties e.g. Seat belts, speeding, etc. This is in contrast to reactive policing when enforcement locations are identified as a result of complaints. In a reactive-only strategy, the policy is deemed to be effective when there are no more complaints.

6.2.5 Special needs of the Urban Poor

During the Problem Analysis phase, the areas of the city suffering from the worst urban poverty should have been identified. Further analysis may reveal that the transport needs of these urban poor may require special treatment, such as the provision of very low cost (subsidised) transport, or the creation of special pedestrian or cycle routes from settlements to areas of employment; or even creating employment adjacent to or within the settlements.



Figure 6-3 Problem of street vendors and stalls

These types of solution will all help to reduce traffic conflicts and therefore reduce accidents and injuries. Clearly, the ill-provision of transport services and exaggerated transport costs in urban areas are a symptom of urban poverty rather than its cause, a situation which is exacerbated by the occurrence of road traffic accidents and fatalities. Identifying these problems and possible solutions should then be an underlying consideration in the overall strategy for the USM project.

Furthermore, care must be taken that the proposed schemes will not have a potential negative impact upon the poor; a typical example might be road safety programme that clears street vendors from footpaths (see Figure 6-3). In this example street vendors and stalls are causing chaos at the junction. Additional measures as part of the schemes must be taken to ensure that there is not a net negative impact upon the poor; for the example in Figure 6-3 this might involve creating an alternative area for the vendors, or widening the footpath at strategic points and confining the vendors to these points; or creating alternative livelihood opportunities for the vendors. It is essential that these alternatives are realistic and do not cause further disadvantages for the people involved.

6.3 The Planning Phase

6.3.1 Engineering and planning schemes

A number of low-cost engineering measures appropriate for area-wide schemes have been developed for use in European countries. These include mini-roundabouts, ghost islands, central hatching, gateways, chicanes, pinch points etc. However, a number of these measures depend upon drivers obeying road signs or markings, and in a number of developing countries, they will have little prospect of being respected. The emphasis, therefore, should be more towards self-enforcing measures; for example, if there is a Head-on accident problem, heavy duty road studs or triangular kerbing (see Figure 6-4) may be more appropriate in the centre of the road than double white lines or hatching. This issue

and a range of possible countermeasures are discussed in TRL's Towards Safer Roads in Developing Countries (TRL, 1991)



TRL, 1991

Figure 6-4: Example of self-enforcing measure: to reduce overtaking on bend

Figure 6-5 shows the engineering scheme proposed for Malleswaram in the Bangalore Case Study. It is attempting to tackle two fundamental types of problem identified in the study: those due to poor design of the road and those due to driver and pedestrian behaviour. It was considered that both modes could be overcome by using engineering methods to modify the road environment and reinforce the hierarchy.

6.3.2 Planning Education schemes

Education schemes, whether targeting school children or the wider public, need to be properly planned, researched, conducted and monitored; and should involve specialists with particular skills in communication. As the primary focus of these guidelines has been on low cost engineering measures the planning of education will not be fully covered here, however the following references might provide a useful starting point for planning such schemes.

TRL's Road Note 17 ('Road Safety in Education in Developing Countries: Guidelines for good practice in primary schools') provides guidance of producing materials for use in schools while GRSP (www.grsproadsafety.org) have recently produced 'Focus notes' on both "Road safety education in schools" and "Road safety publicity campaign" both of which contain a selection of useful additional references.

6.3.3 Planning Enforcement schemes

Effective police enforcement of road safety requires a variety of factors. As well as properly trained and equipped officers, information is required on what particular problems and road users need to be targeted. In the context of these guidelines it is important to recognise that police enforcement activity can be an important element of any USM scheme. A strong

police presence in the early days of a new scheme's introduction may well help road users to understand its intended operations and ensure its effectiveness is sustained. The police are also likely to be involved in a number of other roles such as education and traffic control.

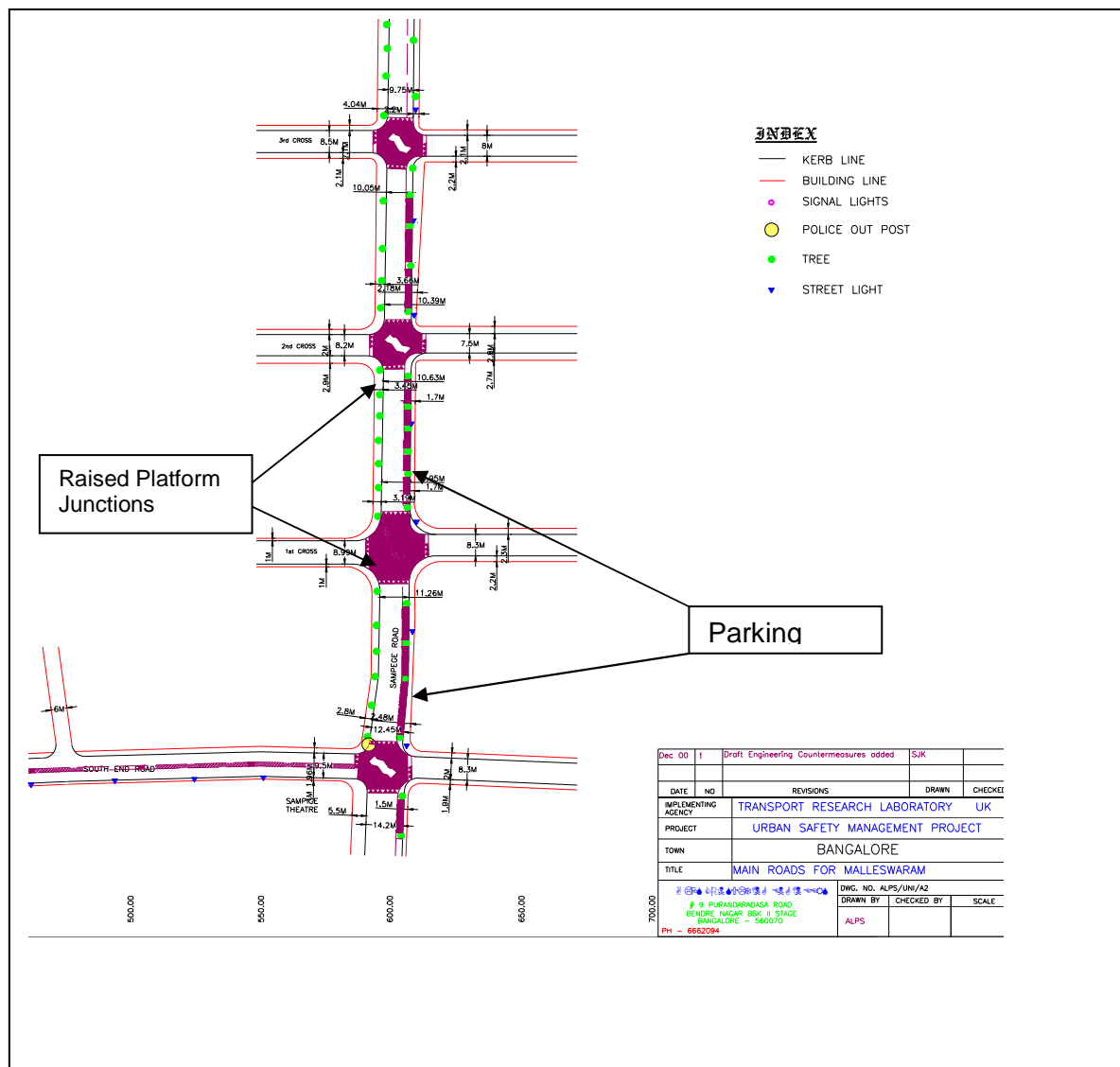

Figure 6-5: Engineering measures in Malleswaram

6.3.4 Initial Prioritisation and Cost-Benefit Estimates of Solutions

Before going to consultation, it will be necessary to make some recommendations of the order of priorities of the solutions, be they engineering, education, enforcement or a combination of these; and, for site specific solutions, the order in which sites might be treated.

In theory, the selection of countermeasures to be implemented should be based on achieving satisfactory accident reductions whose cost savings match or exceed the expenditure planned. Thus, for highly experienced authorities, the standard approach for the ranking of treatments is to carry out a cost-benefit analysis based on *estimated* benefits of the scheme and simply place these in priority order on the basis of the best returns.

The value of carrying out a full cost-benefit appraisal is that there may be a strong case for increasing the budget available. To achieve this, various estimates are required:

- the estimated cost of the scheme
- the estimated reduction in accidents
- the estimated cost of accidents
- an estimate of other benefits, on which it may not always be possible to put a monetary value
- an estimate of all disbenefits (if any)

There may be considerable uncertainty for each of these. In particular, for many countries there is currently little or no data on which to make an estimate of the likely effectiveness of a treatment. In this situation, then perhaps the best way to proceed is to implement the lowest cost schemes first as these are likely to provide the greatest overall benefit. If there is good reason to believe the least cost scheme will prove in practice to be ineffective (e.g. a countermeasure using only road paint) then the alternative schemes in order of increasing cost should be tried. For the UK, experience has shown that for engineering solutions, in most cases a pessimistic estimate of likely accident savings can be assumed to be an average reduction of around 10-15% of all accidents. Such a figure for improved education solutions has proved more difficult to assess due to the longer term nature of the benefits.

Alternative procedures for estimating the average cost of road accidents have been described in TRL's Overseas Road Note 10 (TRL, 1995). However, this is normally the responsibility of a national road safety organisation and is usually beyond the scope of a local authority. Where such accident costings are available, a ranking procedure can be used based on ratios calculated using the First Year Rate of Return or Net Present Value methods of economic assessment outlined in section 8.3.6.

A full cost-benefit appraisal may not be possible for many local authorities for the reasons given above; therefore, the aim will be restricted to prioritising the schemes within the predicted available budget. A simple table might then be drawn up listing the schemes in the initial order of preference:

	Scheme	Estimated Cost	Estimated Reduction in Fatal and Serious accidents	Estimated Reduction in Slight and Damage accidents
1				
2				
3				

The estimates and the rankings will then be the subject of the next Consultation phase and will determine where the line can be drawn in the current financial year to match the available budget.

To minimise costs for engineering solutions, it is recommended that:

- the concepts of Cost and Safety Efficient (CaSE) designs be considered in selecting options. These concepts have been explored in a recent TRL/DFID study and examples can be seen in four CaSE Design Notes (TRL,2002).
- proposals should suggest temporary materials be employed, where possible, for initial trials; for example, pre-cast concrete slabs tied together and pinned to the road surface to try a particular size and position of road narrowing.

6.3.5 Consultation

Once the proposals have been drawn up, the stakeholders should again be consulted. The consequences of solutions proposed should be thoroughly discussed and initial costings of the schemes considered. Once agreed, the process of detailed design and implementation must be discussed. It is important that any timescales that are set should be reasonable to all concerned – with some contingency.

6.4 Appropriate engineering solutions

The previous chapters have described the process of necessary data collection and analysis to help understand the main existing problems which road users face in a local urban network, and then the development of a strategy for solving them. Having followed this process it is now a matter of deciding on the most appropriate measure or package of measures that need to be implemented. There are a variety of measures that can be used to reduce the number of road traffic accidents, and improve road safety. The four E's of Enforcement, Education, Engineering and Encouragement are very commonly cited as the basic ways of helping to reduce road accidents. As indicated in the Introduction (Chapter 1), these guidelines have primarily been developed for local and regional highway authority officers in developing countries whose objective it is to use engineering measures to address road safety issues in urban areas. This Section therefore brings together a number of examples of engineering solutions, in particular, low-cost measures for urban areas in developing countries. The intention is to help officers to consider as wide a range of measures as possible from which to choose remedies to the problems they are trying to solve within the USM general strategy adopted.

Broadly, the engineering solutions can be classified into the following types: -

- (i) improving road user behaviour;
- (ii) provision of facilities for road users; and
- (iii) minimising crash severity

These are discussed briefly below and examples of most individual types of countermeasures, devices or treatments are presented in tabular form with their respective advantages and disadvantages at the end of this chapter.

6.4.1 Improving road user behaviour

One of the major factors in many (if not most) road accidents is road user error, often as a result of poor driver behaviour. There are a variety of measures that can be used to encourage or force better behaviour. Examples of these include: -

Lane dividers and channelisation

One of the most common and severest forms of accident is Head On. Some form of lane divider between opposing flows of traffic is a standard solution, but as indicated above, in many developing countries it is advisable that these be physical in nature and self-enforcing. This has already been illustrated in Figure 6-4 with the triangular kerb first used in Bandung, Indonesia. They can also prevent unsafe U-turns.

Awareness/alerting devices

Drivers drive on expectation and thus at locations where there is potential danger and a need for extra caution, then drivers will obviously benefit from adequate advance warning of this. Signs are probably the cheapest form of warning but should be used sparingly as frequent use, particularly where conditions are apparent, can detract from their effectiveness. They can also be used to alert drivers to a change of environment and necessary adjustment of driving style; for example, the transition from a rural to an urban

situation. This is commonly referred to as a gateway and driver attention to this environment change is best gained using a combination of signs and geometric features.

Electronic vehicle-activated signs are considerably more expensive than conventional warning signs, although they are probably a more effective alerting device since they only light when a relevant (perhaps high speed) driver passes the sensors. Other alerting devices like yellow bar lines can create the illusionary effect to drivers of high speed, hopefully encouraging them to slow down. Alternatively, a combination of visual and audible warning cues can be used in the form of rumble areas, rumble strips or jiggle bars.

Speed-reducing (Traffic calming) measures

This is one of the most common needs in an USM scheme. Excessive speed is one of the most commonly occurring contributory factors in road accidents, and the survivability of road users following a collision has a proven relationship to collision speed. Unfortunately speed limits are widely abused, and many countries do not have sufficient police manpower, training or equipment to enforce them. Road engineering measures to reduce high speeds at hazardous locations or where there are large numbers of pedestrians can therefore make a sizeable contribution to improved safety. 'Traffic calming', in fact, has become a major topic in its own right in Europe in recent years and for an in depth discussion the reader should refer to references such as Hass-Klau et al (1992), County Surveyors Society et al, (1994). Self-enforcing speed reducing devices like road humps or physical width restrictions tend to be particularly effective in keeping speed low. However, they are more appropriate for residential areas or shopping streets as they can introduce adverse effects like congestion or even ground vibration that is noticeable within buildings on heavily trafficked roads.

Banning turns

Vehicles turning into or out of a main road cause conflicts that can lead to traffic congestion and accidents. Therefore, banning turns can be used both for improving traffic management and road safety.

6.4.2 Provision of facilities for road users

Road safety can often be improved by providing facilities for certain groups of road users and sometimes improving existing facilities. Examples of these include: -

Pedestrian facilities

Pedestrians are one of the most vulnerable groups of road users and getting them safely across busy main roads and local distributors is usually one of the largest problems to be solved in a USM project. In many countries, drivers ignore standard painted pedestrian crossings, failing to give way to pedestrians on the crossing or waiting to cross, and even failing to slow in any way. To counteract this problem, raised pedestrian crossings are now being introduced. Whilst they have the advantage of slowing vehicles for pedestrians on the crossing, they have the disadvantage of slowing vehicles even when there are no pedestrians waiting to cross. In some countries where observance of pedestrians on crossings is good, there can be sites where there are so many pedestrians crossing that they cause major hold ups to the traffic. In these circumstances, platooning of the pedestrians is necessary, either by using a traffic policeman or by installing a pedestrian-actuated traffic signal (known in the UK as Pelican crossings).

Channelisation of pedestrians (perhaps by pedestrian barriers, signs, and beacons) to the preferred places where they should be encouraged to cross the road may also be needed. For example, this will be for locations where special provision has been made for pedestrians like zebra crossings, raised crossings, refuge islands, signal-controlled crossings or footbridges.

Central island refuges in the middle of a standard painted pedestrian crossing help pedestrians get across the road more safely by splitting the process into two stages. Sloping the profile of the edge kerbing to the island was found necessary in Nepal to avoid night-time collisions with the previous vertical edged kerbing. In Europe, these refuges have developed into staggered pedestrian crossings.

Pedestrians walking alongside or in the road can be very exposed in many urban environments and can lead to almost as many injuries as to pedestrians crossing the road in some locations. To prevent this, some degree of protection should be provided in the form of segregation (see below); that is, by providing footways separated from the carriageway by a raised kerb or barrier or even special non-motorised pedestrian routes. Sometimes pedestrians object to barriers and jump over them, or have even been known to dismantle the barrier in the night. An ingenious barrier has been designed in Chile that has a rolling top bar to stop pedestrians from climbing over (see below).

Many modern large cities have large multi-lane roads running through them that can be very difficult for pedestrians to cross. Whilst pedestrian bridges can be appropriate in some circumstances (e.g. extremely heavy nose-to-tail traffic), they are less appropriate in others, being expensive with pedestrians frequently reluctant to use them. In several countries, traffic engineers have separated the lanes in one carriageway into two groups with a 1.0 or 1.5 metre wide channelisation (with regular gaps), to help reduce weaving to improve traffic flow (see below). Whilst still not ideal for pedestrians, they can be helpful by allowing the highway to be crossed in three stages. It is proposed here that the following general principle should be applied:

- **Pedestrians should never be expected to cross more than two lanes of free flowing traffic in crossing a major highway**

Perhaps the more basic issue is the extent to which such multi-lane highways, which allow high speeds, are appropriate for the centre of a city.

Segregation

Many problems result from the mixing of different types of traffic. Some road users i.e. pedestrians, cyclists and motorcyclists, are far more vulnerable than those road users travelling in heavier, motorised 4-wheeled vehicles. Segregating fast moving motorised vehicles from these slow moving vulnerable road users is one of the basic tools available to the highway safety engineer. Whilst footpaths and to a lesser extent cycle lanes are familiar in many countries, other forms of segregation have been developed, including special lanes for rickshaws (Nepal) and motor cycles (Malaysia). Therefore, it is important for the designer, wherever feasible, to introduce measures to segregate certain road users in order to minimise the opportunities for collisions to occur, and to improve the urban street environment.

Parking

As well as being a significant element of transport policy in integrating the use of cars in town centres whilst encouraging maximum use of public transport, the provision of parking can have a bearing on road safety. Parking facilities in a commercial area, particularly for the operation of businesses and for visitors (in preference to commuter parking), are necessary for the success of that development. The consequence of failing to make well-planned provision for easy and accessible parking is that cars and commercial vehicles will be parked illegally. This can cause congestion, restrict safe sightlines, and block footpaths forcing pedestrians to walk in the roadway in close proximity to fast-moving traffic.

General Traffic Management

There are many ways in which simply managing the traffic improves road safety. Different measures may well increase speed, but improvements to the general movement of traffic like those following a designated road hierarchy, channelisation, one-way systems, control of street vendors etc can also dramatically reduce accidents.

6.4.3 Minimising crash severity

Whereas reducing vehicle speeds has been shown to reduce the occurrence and severity of accidents, the introduction of other measures that will help to minimise injuries sustained in collisions should also be considered. These are generally two distinct types: those concerned with making the road environment more 'forgiving' and those that depend on the vehicle itself providing protection for its occupants.





Creating a forgiving road environment





In towns and cities careful consideration should be given to the placement of roadside obstacles like lampposts, concrete posts, heavy steel cabinets, such that they are in positions where the likelihood of vehicles hitting them at high speed is minimised. Unavoidable solid features like bridge parapets or other hazardous locations like steep downhill embankments should be protected by energy-absorbing devices like guard rail/crash barriers or crash cushions.





In-vehicle occupant protection





Although obviously not the responsibility of the road engineer, as mentioned earlier, the vehicle itself can be designed to provide a valuable energy-absorbing role in protecting its occupants during a collision. This form of 'secondary' safety in helping to minimise personal injury includes measures such as seat belts or even air bags fitted by manufacturers as well as crash helmets for motorcyclists. When used correctly these devices can dramatically reduce the severity of injury sustained in a collision. However, they do, of course, require appropriate legislation and enforcement of their usage (in the case of seat belts and helmets), and also of their regular inspection and maintenance.





The following pages list and discuss the various types of the above categories of measures and indicate many of their advantages and disadvantages.





	Measure	Location & Purpose	Advantages and Disadvantages
Improving Road User Behaviour	<u>Channelisation</u>	<p>Located on all urban roads to clearly mark carriageway lanes.</p> <p>Guides and directs drivers by improving visual identification of road layout.</p> <p>Discourages unsafe overtaking & vehicles being squeezed.</p>	<p><u>A</u> Possible accident saving of about 33% (Kirk,1997)</p> <p><u>A</u> Roads easier to cross by pedestrians when traffic flowing in orderly lanes</p> <p><u>A</u> Indecision & confusion are minimised resulting in smoother traffic flows.</p> <p><u>D</u> Can reduce capacity, particularly at junctions with mixed traffic</p>
	<p>White lines</p> 	<p>Longitudinal markings can be applied where a lack of lane discipline prevails.</p> <p>Edge and centre lines are used to give clear information to drivers as to the correct position on the road</p>	<p><u>A</u> Improves lane discipline</p> <p><u>A</u> Creates more ordered, smoother traffic flow</p> <p><u>D</u> Local paint may be poor quality, therefore requires to be re-applied regularly</p> <p><u>D</u> Largely ignored in some countries</p> <p>LOW COST</p>
	<p>Raised Rib Lines</p> 	<p>Located along heavily used roads where no-overtaking rule abused.</p> <p>Aim to alert the driver crossing centre of the road.</p> <p>An extra deterrent for overtaking.</p> <p>Target the drowsy or inattentive driver.</p>	<p><u>A</u> Discourage overtaking in dangerous locations</p> <p><u>D</u> Difficult to replenish.</p> <p>MEDIUM COST</p>
	<p>Reflective Studs</p> 	<p>Located in the centre of the carriageway.</p> <p>Used on both lit and unlit roads.</p> <p>Barrier between opposite traffic flows.</p> <p>Alerts the driver to deviations in road direction, i.e. bends, junctions.</p>	<p><u>A</u> Encourages lane keeping by highlighting lanes</p> <p><u>A</u> Useful on unlit or poorly lit roads as they reflect headlights.</p> <p><u>A</u> Stand above road surface and so still visible in wet.</p> <p><u>A</u> Give audible warning when driven over.</p> <p><u>A</u> Low maintenance.</p> <p><u>D</u> Adhesion can be a problem on certain surfaces</p>
	<p>Ghost Median - Hatched Divider</p> 	<p>Aim is to channel traffic with space between opposing carriageways to discourage overtaking.</p> <p>Ideal on non-overtaking horizontal crests and curves.</p>	<p><u>A</u> Encourage lane keeping and discourage overtaking.</p> <p><u>D</u> Can be ignored in some countries</p> <p><u>D</u> Replenishment maintenance.</p> <p><u>D</u> May be used for overtaking or as third lane in congestion</p>







	Measure	Location & Purpose	Advantages and Disadvantages
Improving Road User Behaviour	<p>Raised Hatched Divider</p> 	<p>In the centre of carriageways along busy routes to reduce overtaking Alerts driver when straying into the centre of the road by virtue of very uncomfortable ride.</p>	<p>A Provides both audible and tactile warning. A Strongly discourages overtaking. D May eventually suffer from edge deterioration.</p> <p>MEDIUM COST</p>
	<p>Road stud with reflector on flexible extension</p> 	<p>In the centre of carriageways to reinforce line markings or in advance of channelisation. Creates a clear visual barrier between carriageways or opposing lanes</p>	<p>A Provides visual, audible and tactile warning, if crossed. A Strongly encourages correct lane discipline and largely eliminates overtaking. D May eventually suffer from vehicle damage</p> <p>LOW COST</p>
	<p>Trapezoidal Kerb</p> 	<p>Located at sharp bends and where head on collisions tend to occur The aim of the kerb is to alert the driver if they are too close to the centre of the road, and create a physical barrier between carriageways They target the drowsy, alcohol impaired and inattentive driver, as well as the reckless overtaking driver</p>	<p>A Reduce the number of collisions & prevent crossover accidents A Provides drivers with visual indication/warning of a bend. A Can be driven over in an emergency without loss of control. A Low maintenance. D Can cause drainage problems and may suffer from edge deterioration.</p> <p>MEDIUM COST</p>
	<p>Central raised kerb divider</p> 	<p>In the centre of the carriageway to separate opposite traffic flows Effective where head on collisions predominate</p>	<p>A Prevent lane crossing & head on collisions A Prevents U-turns D Discourages pedestrians crossing at other than designated places. D Visually intrusive. D May cause some vehicle damage if crossed.</p> <p>MEDIUM COST</p>
	<p>Central median kerb</p> 	<p>For wide roads to separate opposing flows and prevent overtaking. Should be painted to increase conspicuity</p>	<p>A Reduce the number of collisions & prevent crossover accidents. A Provides continuous refuge for pedestrians crossing wide roads. A Reduced width may encourage lower speeds on single carriageways. A Prevents U-turns D May require provision of additional drainage.</p> <p>HIGH COST</p>

	Measure	Location & Purpose	Advantages and Disadvantages
Improving Road User Behaviour	<u>Delineation</u>	Can be regarded as a form of channelisation and is simply a means of clearly marking edge limits of lanes or giving indication of changes in direction of the road. Allows the driver to control the positioning of vehicle in traffic lane. Targets single vehicle run-off-the-road & loss-of-control accidents with opposing traffic streams.	
	Edge Lines 	Should ideally be marked on all major and distributor urban roads when there is no raised edge kerbing. Line material should be of reflective material. Allows drivers to position vehicle laterally in vehicle lane.	<p>A Low cost measure that encourages drivers to stay positioned and in lane</p> <p>A Visual warning of bends in road ahead.</p> <p>A Useful for drivers, and particularly cyclists, in reduced visibility conditions or hours of darkness.</p> <p>D Regular replacement (or replenishment) maintenance required.</p> <p>LOW COST</p>
	Raised rib edge lines 	Should be located on major roads, particularly on long straight sections. Aim is similar to standard edge line but also to alert the driver when driving too close to the road edge.	<p>A Alert the inattentive, drowsy or alcohol impaired driver</p> <p>A Help protect pedestrians and reduce accidents</p> <p>A Helps prevent run-off-road vehicles colliding with road furniture and off road hazards.</p> <p>D Difficult to replenish.</p> <p>MEDIUM COST</p>
	Edge Marker Posts 	To provide visual cue as warning to driver of a change in alignment of road ahead and allow correct positioning of vehicle. Useful in poorly lit areas if marker posts are reflective.	<p>A Positive impact on speed and placement of vehicle through curved sections of road.</p> <p>A Low maintenance.</p> <p>A Cause minimal damage to vehicle in a collision.</p> <p>D Can have effect of increasing average speeds at night-time.</p> <p>LOW COST</p>
	<i>Awareness/Alertin</i> <i>Devices</i>	Various devices available to warn drivers in advance of a particular hazard.	
	Rumble Strips & Rumble Areas 	Small raised areas of course aggregate with a vibratory audible and visual effect when driven over. Located on carriageway and/or across road shoulder. Alert drivers if they drift off the main carriageway, or if they enter a hazardous area e.g. entering a residential area/before a crossing. Should not ideally be located within 200metres of residential properties.	<p>A Alert driver to potential hazard ahead or, if only on shoulder, they have drifted off the road.</p> <p>A Can be spaced closer nearer to hazard to give illusion of increasing speed.</p> <p>D Causes noise pollution for local residents</p> <p>D Aggregate can 'pick out' if not properly adhered to road surface.</p> <p>MEDIUM COST</p>

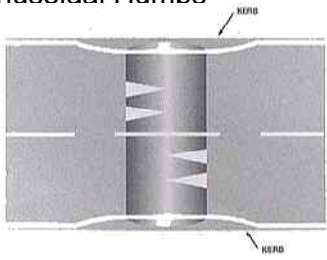
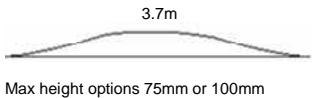

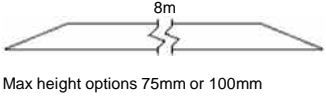

	Measure	Location & Purpose	Advantages and Disadvantages
Improving Road User Behaviour	Rumble strips 	Located across the carriageway in advance of a hazard. Associated road signs should give exact nature of the hazard. Severity and frequency can be varied according to the degree of hazard	<ul style="list-style-type: none"> <u>A</u> Alert drivers of dangers ahead. <u>A</u> Can be spaced closer to hazard to give illusion of increasing speed. <u>D</u> Causes noise pollution for local residents LOW COST
	Jiggle Bars  <small>Source:DFT</small>	Located across the carriageway. Found at entrance to villages, where there is a speed limit change or as a warning to potential dangers ahead. Alert drivers to the dangers of the road.	<ul style="list-style-type: none"> <u>A</u> Alert drivers of dangers ahead. <u>A</u> Can be spaced closer to hazard to give illusion of increasing speed. <u>D</u> Causes noise pollution for local residents LOW COST
	<u>Road Signs</u>	Road signs and markings are expected and relied upon by road users as a part of the operation of the transport network. Can be for the purpose of either warning, regulatory or route information. Thus their positioning to be clearly visible at all times is essential.	
	Warning Signs 	Used in advance of potentially hazardous features for which drivers may need to slow down. Located ideally where it will break the drivers line of sight. Vehicle activated signs warn individual drivers of potential dangers & can give advised speed required to negotiate them safely	<ul style="list-style-type: none"> <u>A</u> An accepted requirement for warning of road feature or junction ahead. <u>A</u> Low maintenance and do not require special illumination if retro-reflective. <u>D</u> Can be stolen or vandalised. LOW COST
	Vehicle activated Warning Signs 	Used in advance of particularly bad hazardous locations for which drivers need to be continually warned (eg. uncontrolled crossroads, sharp bend). Vehicle activated signs (normally blank) warn individual drivers of potential dangers & can give advised speed required to negotiate them safely	<ul style="list-style-type: none"> <u>A</u> Have a good effect on slowing vehicles down at potentially dangerous locations. <u>A</u> Targeted at errant drivers <u>D</u> Relatively expensive to install <u>D</u> May need special provision of electricity supply. <u>D</u> Requires regular maintenance. <u>D</u> Can be vandalised. MEDIUM COST
	Chevron Boards 	A type of warning sign, chevron boards are located on hazards such as sharp bends or roundabouts. The aim is to warn drivers to prepare for a sharp curve, and slow down to a suitable speed to negotiate it.	<ul style="list-style-type: none"> <u>A</u> Help prevent run off the road accidents around sharp bends. <u>A</u> Particularly effective at night-time if retro-reflective. <u>A</u> Can be highly cost-effective <u>D</u> As normally sited in line of sight where vehicles need to be turning, can be hit regularly and require replacement. 6.4.2.1.2 LOW COST





	Measure	Location & Purpose	Advantages and Disadvantages
Improving Road User Behaviour	Regulatory Signs  <small>Source: Freefoto.com</small>	<p>Used to advise road users of local road regulations (eg. speed limits, priority rules, prohibitions).</p> <p>Aims are to inform and encourage drivers to follow the laws of the road.</p>	<p>A <u>Low maintenance.</u></p> <p>D <i>Often abused by drivers e.g. average speeds are regularly above the posted limit, and prohibitions often ignored in some countries: therefore they cannot be relied on to work sufficiently well on their own.</i></p> <p>D <i>Require strict enforcement</i></p> <p>LOW COST</p>
	Informative Signs  <small>Source: Freefoto.com</small>	<p>Positioned well in advance of junctions and slip roads.</p> <p>Provide road users with location and road number information that they may need to continue their journey. Also give advanced warning of junction (and type, eg. roundabout) ahead.</p>	<p>A <u>Potential to reduce mileage travelled of all vehicles by directing traffic correctly and efficiently.</u></p> <p>A <u>Secondary benefit of providing warning of junction ahead.</u></p> <p>A <u>Less congestion.</u></p> <p>A <u>Low maintenance.</u></p> <p>D <i>Requires full coverage over the network.</i></p> <p>LOW COST</p>
	Road markings  <small>Source: Freefoto.com</small>	<p>Located on any road where there is a need to convey information or warnings. There are many types of road markings;</p> <p>e.g. "STOP" at intersections, "SLOW" before a bend or other potentially hazardous location, and speed limit roundels.</p> <p>Markings can also be centre or edge lines, arrows to direct, or diagonal stripes to separate traffic streams.</p>	<p>A <u>Information relayed by placement actually in drivers' line of sight.</u></p> <p>A <u>Regulations applying along long road sections can be made by lining.</u></p> <p>A <u>Significant contribution to the safe and efficient operation of the road network</u></p> <p>D <i>Require frequent repainting or more expensive thermoplastic replenishment.</i></p> <p>LOW COST</p>
	<p><u>Speed-reducing (traffic calming) measures</u></p>	<p>In places where signing is insufficient to reduce drivers' speeds, various types of self-enforcing engineering measures can be considered.</p>	
	Throttles/ Narrowings 	<p>Located in areas with a low speed limit but where vehicles regularly break this limit</p> <p>To slow vehicles down</p> <p>Force opposite flows of traffic to give way to each other</p>	<p>A <u>Reduce vehicle speed dramatically.</u></p> <p>A <u>Allow 2-wheelers to continue their journey undisturbed.</u></p> <p>A <u>No land take necessary.</u></p> <p>A <u>Reduced road width aids pedestrians to cross the road.</u></p> <p>D <i>Confusion can arise over priority direction unless clearly marked and understood.</i></p> <p>MEDIUM COST</p>
	Deflection by centre island 	<p>Located at entrance to or in areas with a low speed limit but where vehicles regularly break this limit.</p> <p>To slow vehicles down.</p>	<p>A <u>Reduce vehicle speed.</u></p> <p>A <u>Minimal land take necessary.</u></p> <p>A <u>Could be combined with pedestrian crossing.</u></p> <p>D <i>Good signing and lighting required</i></p> <p>MEDIUM COST</p>





	Measure	Location & Purpose	Advantages and Disadvantages
Improving Road User Behaviour	Carriageway Narrowing 	<p>On high speed dual carriageways, usually approaching junctions or crossings.</p> <p>Purpose is to slow traffic down and deter overtaking (and line-of-sight blocking*) by narrowing the carriageway to single lane, but allowing more space for cyclists.</p> <p>*Minor road driver can have view of overtaking vehicle blocked by nearer overtaken vehicle</p>	<p>A Helps reduce traffic speed.</p> <p>A Helps emerging drivers as it prevents visual blocking of overtaking vehicles at approach to junctions.</p> <p>A Provides safer environment for cyclists.</p> <p>A No land take necessary.</p> <p>D Reduces capacity.</p> <p>LOW COST</p>
	Gateways 	<p>Located to mark the entry usually from a rural area into an urban environment.</p> <p>Aims to reduce speed of vehicles to more appropriate level to cope with the potential dangers & hazards.</p> <p>Must be conspicuous to be effective.</p>	<p>A Proven speed reduction by up to 6mph (DFT, 2001).</p> <p>D Requires extensive signage – chance of theft or vandalism</p> <p>LOW COST</p>
	Chicanes  <p>Source: DFT</p>	<p>In areas to reduce traffic speed dramatically where flows are low but ground vibrations may be a problem</p> <p>To force drivers around obstacles thereby reducing vehicle speeds.</p>	<p>A Reduces vehicle speeds in residential areas.</p> <p>A Less discomfort for passengers than road humps.</p> <p>D Vehicles can collide with kerb</p> <p>D Noise pollution for local residents</p> <p>D Confusion can arise over priority direction unless clearly marked and understood.</p> <p>LOW COST</p>
	Vertical Deflective Devices	<p>Located in residential areas where pedestrian-vehicle conflicts occur and vehicles regularly break speed limits.</p> <p>Constructed in the carriageway and designed to slow traffic.</p>	<p>A Force traffic to slow down due to discomfort of travelling fast.</p> <p>A Effective 24 hours per day.</p> <p>A Cause fewer pedestrian casualties</p> <p>A Provide safer environment and locations for pedestrians to cross</p> <p>D Unpopular with emergency services</p> <p>D Cause visual and audible disturbance for local residents.</p> <p>D Increase in pollution due to stopping and starting</p>
	Round Top Humps  <p>Source: DFT</p>	<p>100mm or 75mm high and 3.7 metres long, appropriate for areas with a 30mph (50km/h) or less speed limit</p>	<p>A When laid as a series, produces dramatic speed reduction.</p> <p>A Provide safer environment and locations for pedestrians to cross</p> <p>D Slow emergency vehicles and buses to same extent as private vehicles.</p> <p>D Can cause localised congestion</p> <p>D Can cause transmitted ground vibration to adjoining buildings.</p> <p>LOW COST</p>





	Measure	Location & Purpose	Advantages and Disadvantages
Improving Road User Behaviour	Sinusoidal Humms 	Similar to round top humps, but with a shallower initial rise. 	<p>A Produce slightly less discomfort for cyclists and vehicle occupants.</p> <p>D As above</p> <p>D Difficult to construct.</p> <p>LOW COST</p>
	Flat Top Hump 	Create flat area flush with footways to slow traffic and assist pedestrians to cross. 	<p>A Above advantages.</p> <p>D Cause discomfort for vehicle occupants, including cyclists.</p> <p>D Can cause pedestrian to assume priority and forget to check for traffic.</p> <p>D Extensive additional edge drainage work required</p> <p>MEDIUM COST</p>
	Speed Cushions 	Preferred along routes heavily used by buses. Aim is to slow down cars & other private vehicles whilst allowing easier passage for emergency vehicles and buses. 75mm high, 2000mm - 3700mm long, 1600mm - 2000mm wide	<p>A Allows easier passage by buses and emergency services</p> <p>A Generally preferred by residents and drivers.</p> <p>D Can be negotiated at slightly higher speeds than humps.</p> <p>D Can lead to drivers suddenly adjusting lateral position of their vehicles to minimise effect.</p> <p>LOW COST</p>
	Speed Cushions/Centre island 	Combines benefits of speed cushion and centre island/ pedestrian refuge	<p>A Allows easier passage by buses and emergency services</p> <p>A Additional conspicuity over just speed cushions</p> <p>A Assists pedestrians across the road</p> <p>A Prevents drivers altering lateral position to try to minimise speed discomfort</p> <p>D As for Speed Cushions</p>
	Thump 	Located on routes with low speed restrictions. To slow traffic.	<p>A Generally preferred by drivers as they can be negotiated at higher speeds.</p> <p>D Can be crossed at higher speeds than humps and cushions.</p> <p>D Bus companies claim higher maintenance of vehicles required.</p> <p>D May tend to get deformed in hot weather.</p> <p>LOW COST</p>



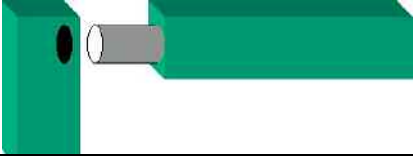

Measure	Location & Purpose	Advantages and Disadvantages
<p>Raised Junctions/Speed Table</p> 	<p>Aim to raise profile and thus highlight position of priority junction, and force drivers to adopt slower speeds through it.</p>	<p><u>A</u> Above advantages. <u>A</u> Safer and easier turning manoeuvres for drivers on minor arms. <u>D</u> Requires additional drainage works.</p> <p>HIGH COST</p>





	Measure	Location & Purpose	Advantages and Disadvantages
Improving of Facilities for Road Users	<u>Pedestrian Facilities</u>		
	Footpaths	Footpaths should cover a whole area and link all the important generators of pedestrian traffic, e.g. schools, shops, residential areas, parks etc. Aim is to clearly segregate vulnerable pedestrians from motorised traffic.	<u>A</u> Reduce and eliminate pedestrian-motorised transport conflicts. <u>D</u> Can become encroached by traders or parked vehicles forcing pedestrians into carriageway.
	Raised Kerb footpaths 	Located adjacent to busy carriageways and in residential areas. Purpose is to segregate pedestrians and vehicular traffic with a footpath raised above the level of the carriageway. Shallow slope dropped kerbs for driveways preferable so as not to deter pedestrian use.	<u>A</u> Reduce & eliminate pedestrian-motorised transport conflicts <u>D</u> High cost if installed along most routes <u>D</u> Additional kerbside drainage gulleys required. HIGH COST
	Barrier Kerb footpaths 	Located where footpaths are adjacent to busy carriageways Aim to segregate vehicular traffic and pedestrians with a physical barrier.	<u>A</u> Defines footpath <u>A</u> Prevents vehicles from encroaching the footpath i.e. for parking etc <u>A</u> Much lower cost than raised footpaths. <u>D</u> Can cause severe injuries in motorcycle collisions. MEDIUM COST
	Segregated footpath 	Located adjacent to busy and high speed carriageways . Purpose is to segregate pedestrians and vehicular traffic with the footpath separated away from the carriageway.	<u>A</u> Maximises segregation between pedestrians and high speed traffic conflicts <u>A</u> Drainage channel can be located between carriageway and footpath <u>D</u> Greater land take necessary. HIGH COST
	Crossings	Located where there are large numbers of pedestrians crossing carriageways Aim to allow pedestrians to cross the road safely	<u>A</u> Reduce the number of pedestrian casualties <u>D</u> Disrupts vehicle traffic flow.
	Zebra 	Located in a highly visible location where there are already large numbers of pedestrians choosing to cross the road. Allow pedestrians to cross with higher priority, and thus more safely.	<u>A</u> Low maintenance <u>D</u> May require installation of barriers to channel pedestrians to crossing and also of special lighting. <u>D</u> Drivers often fail to observe legal requirement to give way to pedestrians. LOW COST





	Measure	Location & Purpose	Advantages and Disadvantages
Improving of Facilities for Road Users	<p>Raised Crossing</p> 	<p>Located where there is a need for the pedestrian crossing to be more visible for drivers and ensure low speeds.</p> <p>Aims to increase pedestrian conspicuity to drivers</p> <p>Used in conjunction with round-top and flat top humps</p>	<p>A Drivers are more likely to stop if pedestrians are more visible and they are already slowing to negotiate hump.</p> <p>D Requires additional drainage as it should be constructed kerb to kerb to avoid trip.</p> <p>D Drivers may still not give way to pedestrians already on crossing.</p> <p>MEDIUM COST</p>
	<p>Pelican</p> 	<p>Pedestrian light controlled crossings can be located where there are larger volumes of pedestrians (particularly children, elderly or infirm) crossing the road, requiring traffic lights to stop traffic</p> <p>To allow them to do so safely.</p> <p>Can have tactile knob as signal for blind/partially sighted pedestrians.</p>	<p>A Vehicles are more likely to stop at traffic lights than at a zebra crossing</p> <p>A Reduces pedestrian delay and casualty numbers</p> <p>A By platooning pedestrians, can reduce vehicle delays when pedestrian flows are heavy.</p> <p>D Requires pedestrian to know that request button must be pressed.</p> <p>D Can lead to unnecessary vehicle delay when pedestrians cross early.</p> <p>HIGH COST</p>
	<p>Toucan</p>  <p>Source:DFT</p>	<p>Located where pedestrians and cyclists cross the carriageway at the same location (ie. 'two-can')</p> <p>On major roads where there are many pedestrian/cyclist-vehicle conflicts</p>	<p>A Similar advantages to the above</p> <p>A Allows both pedestrians and cyclists to cross a busy carriageway safely together.</p> <p>D Requires additional road space to accommodate both road user groups.</p> <p>HIGH COST</p>
	<p>Pedestrian Refuge</p> 	<p>Where there are 2 or more lanes of relatively heavy traffic & pedestrian crossing movements do not justify a more formal crossing.</p> <p>Provide a safe haven for pedestrians when crossing more than one traffic stream.</p>	<p>A Allow easier crossing for pedestrians since they only have to make decision about 1 traffic stream at a time.</p> <p>A Helps to segregate traffic streams and reduce overtaking.</p> <p>D Require arrow marker sign or bollard</p> <p>D Risk of vehicles colliding with refuge, particularly at nighttime.</p> <p>MEDIUM COST</p>
	<p>Pedestrian Crossing/Refuge</p> 	<p>At a pedestrian crossing where there are 2 or more lanes of heavy traffic & pedestrian crossing movements</p> <p>Design from Nepal uses sloping profile of edge kerbing to avoid effects of nighttime collisions</p>	<p>A Allows easier crossing for pedestrians since it divides the task into two stages</p> <p>A Helps to segregate traffic streams and reduce overtaking.</p> <p>A Lower risk of vehicle damage/loss of control if refuge hit.</p> <p>D Requires reflectors</p> <p>MEDIUM COST</p>



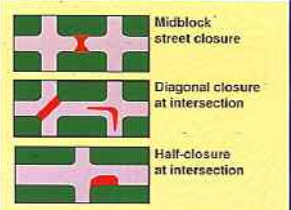

	Measure	Location & Purpose	Advantages and Disadvantages
Improving of Facilities for Road Users	Bridge 	Located where heavy traffic flows mean that there is no other alternative for pedestrians to cross the road safely. Allows pedestrians to cross any busy road without risk of collision and without disrupting traffic flows	<ul style="list-style-type: none"> <u>A</u> Very safe segregated crossing for pedestrians <u>D</u> Forces pedestrians to take a longer route to cross the road and climb stairs. <u>D</u> Require installation of long sections of pedestrian barrier to channel pedestrians to use bridge. HIGH COST
	Underpass 	As for bridge. Decision as to whether bridge or underpass constructed based on pros and cons, cost and physical situation at site	<ul style="list-style-type: none"> <u>A</u> As above. <u>A</u> Less visually intrusive than bridge. <u>D</u> As above. <u>D</u> Requires installation of vandalism-resistant lighting for pedestrian security and confidence. <u>D</u> Requires provision of appropriate
	<u>Segregation</u>	Required in areas where there are conflicts between motorised, non-motorised and pedestrian traffic. Aim to reduce the number of seriously-injured casualties. One of the most important measures available to traffic and safety engineers.	<ul style="list-style-type: none"> <u>A</u> Fewer conflicts involving vulnerable and motorised road users, and thus fewer serious accidents. <u>D</u> Additional construction, land-take and maintenance costs.
	Pedestrian Guard Rail - Centre 	Used on crossing roads carrying heavy volumes of traffic as a means of preventing pedestrians from crossing at points other than where there are crossing facilities.	<ul style="list-style-type: none"> <u>A</u> Reduce locations where pedestrians and vehicles may be in conflict. <u>D</u> Force people to walk further to cross the road, thus if overused, pedestrians will ignore them and climb over/through them. <u>D</u> Visually intrusive <u>D</u> Liable to damage/theft MEDIUM COST
	Pedestrian Guard Rail – Edge 	Channel pedestrian traffic onto a crossing and away from dangerous sites. Can also be used to prevent vehicles from parking on the footpath	<ul style="list-style-type: none"> <u>A</u> Reduce locations where pedestrians and vehicles may be in conflict. <u>A</u> Reduces temptation to cross to centre of road. <u>D</u> Force people to walk further to cross the road, thus may be climbed. <u>D</u> Both sides, thus more expensive <u>D</u> Visually intrusive <u>D</u> Liable to damage/theft

	Measure	Location & Purpose	Advantages and Disadvantages
Improving of Facilities for Road Users	Guard Rail – Climb over deterrent 	Novel barrier design from Chile that has a rolling top bar that makes it almost impossible for pedestrians to climb over. The wire mesh is flush with the bottom rail so that there is nowhere to place the foot. 	<ul style="list-style-type: none"> A As above. A Prevents pedestrians climbing over the guard rail at dangerous locations D As above. D More expensive D Requires a degree of maintenance as ingress of dirt/corrosion may inhibit bar rotation. <p>HIGH COST</p>
	High-Visibility Guard Rail 	Located close to pedestrian crossings which may have high child usage to enable drivers to see children and low objects behind the barrier. Channel pedestrians to crossing points.	<ul style="list-style-type: none"> A At oblique angle, drivers able to see through barrier – gives better warning of children liable to run out into road. A Stronger and less likely to suffer vandalism. D Both sides, thus more expensive D Visually intrusive D Occupies slightly more pedestrian footpath space. <p>HIGH COST</p>
	Carriageway Divider 	Located in the centre of a carriageway with three or more lanes in one direction of traffic. Enforces driver lane discipline but also assists pedestrians to get across multi-lanes. <i>Pedestrians should never be allowed to cross three or more lanes</i>	<ul style="list-style-type: none"> A Assists pedestrians get across urban arterials when multiple pedestrian crossings or bridges not practical. A Promotes smooth flow of traffic D Pedestrians being allowed to cross such multi-lane urban freeways is not desirable, and suggests poor planning. D Pedestrians should only be allowed to cross such highways if speeds controlled to 50 kph or less <p>HIGH COST</p>
	Rickshaw Lane 	Located in areas where there are many conflicts between slow moving vehicles and motorised traffic. Faster through traffic uses two centre lanes. Segregates rickshaws and other slow moving vehicles from motorised traffic.	<ul style="list-style-type: none"> A Produces segregation (if enforced) and feeling of security for slow moving vehicles. A Assists pedestrians in the task of crossing the road. D Requires land take from the carriageway or footpath. <p>HIGH COST</p>
	Cycle Lanes 	Located in areas where there are many conflicts between cycles and motorised traffic, especially at or near junctions Segregate cycles from motorised traffic Also allows motorcycles to be segregated from other larger vehicles	<ul style="list-style-type: none"> A Produces segregation (if enforced) and feeling of security for cyclists. D Requires land take from the carriageway or footpath. D Can cause safety problems at junctions – if lane on raised kerb , best to set crossing place of minor road ~15m upstream. <p>MEDIUM COST</p>

	Measure	Location & Purpose	Advantages and Disadvantages	
Improving of Facilities for Road Users	Motorcycle Lanes 	<p>Tend to be used only where motorcycle usage is extremely high on major high-flow arterials.</p> <p>Aim is to segregate motor cycles from motorised traffic</p>	<p>A Produces segregation and feeling of security for motorcyclists cyclists.</p> <p>D Requires land take from the carriageway.</p> <p>D Construction of segregated lanes at interchanges particularly expensive.</p> <p>HIGH COST</p>	
	Bus Lanes 	<p>Located along busy carriageways that often suffer delays due to heavy traffic.</p> <p>Aim is to allow buses to continue their journey with minimum disruption from other road users.</p>	<p>A Allows buses to travel unhindered, minimising delay and with fewer conflicts with other vehicles.</p> <p>A Allows other more vulnerable road users i.e. cyclists and rickshaws, to use bus lane – minimising risk from other larger vehicles</p> <p>D Reduces capacity of road for other traffic.</p> <p>HIGH COST</p>	
	Bus lay-bys 	<p>Located off major roads with heavy traffic flows where buses are required to stop.</p> <p>Lay-bys allow buses to stop for waiting and dismounting passengers safely whilst still allowing a continuous traffic flow.</p>	<p>A Allows continuous traffic flow</p> <p>A Greater safety for mounting and dismounting passengers</p> <p>D Requires additional land-take.</p> <p>D In high traffic volumes, bus drivers may have difficulty in re-entering the traffic.</p>	
	Junction Treatments		<p>Accidents on the network usually cluster at or near junctions. Various features can be introduced in the design to minimise hazards</p>	
	Major - Minor Priority 	<p>At-grade junction of major and minor road(s).</p> <p>Aim is to ensure users of the minor road reduce speed and either stop or give way to major road traffic.</p> <p>Requires clear marking in advance of junction and with signs at junction and road surface marking.</p>	<p>A Clear definition and signing/markings help to inform of the priority.</p> <p>D Relies on drivers obeying priority rules and having consistent judgement to accept only safe gaps.</p> <p>LOW COST</p>	
	Roundabouts 	<p>Suitable at intersections where traffic flow volumes on all entries are similar and turning traffic is heavy.</p> <p>Located normally at cross roads rather than T-junctions.</p> <p>Aims to slow traffic down around intersections and reduce the number of collisions whilst continuing the flow of traffic.</p>	<p>A Allow traffic to flow through junction smoothly and aid merging manoeuvres.</p> <p>A Ensures slow approaches on all arms of the junction (not just minor).</p> <p>D Needs greater land take sufficient to permit swept turns of heavy vehicles.</p> <p>D Relies on drivers obeying 'give way to circulating flow' rule.</p> <p>MEDIUM COST</p>	

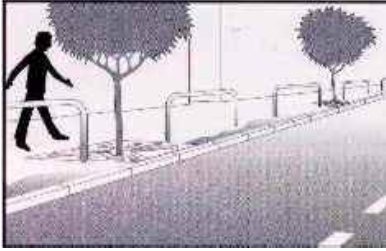
	Measure	Location & Purpose	Advantages and Disadvantages
Improving of Facilities for Road Users	<p>Mini Roundabouts</p> 	<p>Suitable at intersections where traffic flow volumes on all entries are similar and turning traffic is heavy, leading to frequent collisions</p> <p>Mini roundabouts should be located at smaller junctions with less dense traffic.</p> <p>Aims to slow traffic down around intersections where there is insufficient space for larger roundabout.</p>	<p>A Helps traffic from the minor road to emerge.</p> <p>A Ensures slow approaches on all arms of the junction (not just minor).</p> <p>A Reduces and minimises the severity of collisions</p> <p>D Need to be well marked giving advanced warning to drivers.</p> <p>D My need local enforcement.</p> <p>LOW COST</p>
	<p>Signals</p> 	<p>Located at junctions where there are generally high traffic volumes on the major (or both) roads, and drivers have difficulty in making manoeuvres.</p> <p>Aim to allow vehicles from all directions to make manoeuvres more easily.</p>	<p>A Force vehicles to stop and allow traffic from other directions to make crossing manoeuvres.</p> <p>D Need regular maintenance, emergency cover and continuous power supply.</p> <p>D Requires extensive signing, and possibly enforcement.</p> <p>HIGH COST</p>
	<p>Splitter Islands</p> 	<p>Located where one road joins another, especially where there is an uninterrupted sightline across junction and drivers regularly continue straight over the road without stopping.</p> <p>Aim to make drivers notice the junction and give appropriate priority – and keep to correct lane.</p>	<p>A Increases conspicuity of junction.</p> <p>A Ensures drivers do not 'cut the corner'.</p> <p>D Requires wide junction mouth to accommodate island.</p> <p>D Requires arrow sign or bollard on island.</p> <p>MEDIUM COST</p>
	<p>General Traffic Management</p>	<p>Improvements to the general movement of traffic can improve safety; eg. follow designated road hierarchy, channelisation, one-way systems, control of street vendors.</p>	
	<p>One-way Systems</p> 	<p>Located usually in urban centres</p> <p>Aims to create circular flow of traffic throughout the area to produce a more organised traffic flow with fewer conflict points.</p>	<p>A Increase potential capacity for the route</p> <p>A Fewer pedestrian-vehicle and vehicle-vehicle crossing conflicts</p> <p>A May allow improved parking</p> <p>D Requires extensive signing</p> <p>D Higher vehicle speeds than 2-way.</p> <p>D Local traders may object (reduces trade from one direction).</p> <p>MEDIUM COST</p>
<p>Road Closures</p> 	<p>Particularly applicable to residential areas with grid-iron layout. Reduces the number of cross-roads which have highest accident rates of any junction.</p> 	<p>A Increased safety through lower speeds and reduction of through traffic.</p> <p>A Can be incorporated in local environmental improvement scheme</p> <p>A Prevents rat-running (main road traffic using side roads) and reduces high speeds.</p> <p>D Requires extensive local consultation</p> <p>D Requires good signing.</p> <p>HIGH COST</p>	

	Measure	Location & Purpose	Advantages and Disadvantages
Improving of Facilities for Road Users	Banning turns 	<p>Particularly applicable on main roads and local distributors.</p> <p>By reducing conflicts, improves safety and traffic flow.</p> <p>Islands can also assist pedestrians in crossing the road.</p>	<p>A Increased safety and traffic flow on main road</p> <p>A Can be incorporated in local environmental improvement scheme</p> <p>D May force some traffic to use residential streets if not part of wider USM scheme</p> <p>D Requires good signing and lighting.</p>
	Lighting 	<p>To provide adequate contrast for drivers to see objects against a bright road surface.</p> <p>About one third of all accidents occur during dawn, dusk or dark, improved lighting could reduce these.</p> <p>More important at potential hazardous locations (eg. around intersections, pedestrian crossings).</p>	<p>A Cyclists and pedestrians are more conspicuous.</p> <p>A Can reduce public anxiety of robbery and assault.</p> <p>D High cost to install and maintain and they require constant power supply.</p> <p>D Increased number of street lights can lead to an increased number of collisions with roadside objects.</p> <p>HIGH COST</p>
	Street Vendor Management 	<p>Reduce the number of illegal street vendors along major urban routes</p> <p>Prevent encroachment of footpaths and carriageway to allow undisturbed traffic flows.</p> <p>Provide adequate parking facilities and facilities for pedestrians</p>	<p>A Improves urban environment</p> <p>A Allows pedestrians full access to the footpath, and vehicles to the carriageway, reducing risk of accidents.</p> <p>D Requires large amount of land-take, particularly if full service road provided.</p> <p>HIGH COST</p>
	<p style="text-align: center;">Controlling Parking</p>	<p>In urban centres where there area problems with illegally parked vehicles.</p> <p>To control illegally parked cars, and force them to use parking facilities or minor roads</p> <p>To improve conditions for pedestrians and improve the urban environment</p>	
	Guard Rails/Pedestrian barriers  <p>Source:DFT</p>	<p>Can be used where there are problems with illegal parking, and parking on footpaths</p> <p>Aim is to channel pedestrians to particular crossing points, and prevent illegal parking</p>	<p>A Prevents parking on footpaths.</p> <p>A Channels pedestrians to safer areas to cross.</p> <p>D Susceptible to damage/theft.</p> <p>MEDIUM COST</p>
	Bollards  <p>Source:DFT</p>	<p>Aim to prevent vehicles from mounting the footpath where there is no need to restrict pedestrians from crossing (eg. on less busy service roads).</p>	<p>A Help to define footpath, eg. at raised junctions.</p> <p>A Less visually intrusive than full barrier.</p> <p>A Can protect shop fronts from 'ram' raids.</p> <p>D Can be a hazard for blind/partially sighted pedestrians.</p> <p>D Can be fairly high maintenance if regularly hit by drivers.</p> <p>LOW COST</p>

	Measure	Location & Purpose	Advantages and Disadvantages
Improving of Facilities for Road Users	<p>Amenity railings</p>  <p>Source:DFT</p>	<p>Open railing constructed from 50mm diameter tubing 1.5m - 2.5m long.</p>	<p>A As above A Popular with cyclists for securing parked bicycles. D As above MEDIUM COST</p>
	<p>Wire railings</p> 	<p>0.5 - 1m high, supported by posts 1 - 3m apart Best used in conjunction with landscaping.</p>	<p>A As above A Popular with cyclists for securing parked bicycles. D As above D Can occupy slightly greater width of footpath MEDIUM COST</p>
	<p>Raised Planters</p>  <p>Source:DFT</p>	<p>Fixed or movable planters can be used to form a barrier to vehicles parking on pavements</p>	<p>A Prevent parking on the footpath A Provide a physical barrier to protect from vehicles mounting the footpath D High maintenance overhead. D Requires large area of footpath space. HIGH COST</p>
	<p>High kerb</p>  <p>Source:DFT</p>	<p>Aim to prevent vehicles mounting the kerb by raising the height of the kerb so that vehicles physically cannot mount it</p>	<p>A Prevents parking on footpath and helps to deflect out-of-control vehicles. D Hazardous for pedestrians when crossing the road, and when walking close to the edge of the footpath. HIGH COST</p>

	Measure	Location & Purpose	Advantages and Disadvantages
Minimising Crash Severity	<u>Creating a forgiving road environment</u>		
	Crash Barriers 	Normally only used on roads carrying fast, heavy traffic in urban locations (eg. dual carriageways). Aims to absorb energy of impact and deflect vehicles back onto the main carriageway avoiding solid roadside objects or drops down embankments.	<p>A When an out-of-control vehicle leaves the carriageway, crash barriers will prevent it from moving onto the opposite carriageway or colliding with street furniture.</p> <p>A The energy-absorbing properties of crash barriers are likely to lead to less severe injuries.</p> <p>D Visually intrusive.</p> <p style="text-align: right;">MEDIUM COST</p>
	Crash Cushions 	Located where greater protection required before solid objects as risk of head-on collisions with object is high (eg. end of rigid crash barrier where slip road leaves dual carriageway). Aim to absorb much of energy of vehicle impact through steel compression or water filling.	<p>A Proven to absorb significant energy in a collision and reduce crash severity.</p> <p>A Protect street furniture.</p> <p>D May require regular reinstatement after crashes.</p> <p style="text-align: right;">MEDIUM COST</p>
	Escape Ramps & Arrestor Beds 	Used along or at end of steep downhill slopes. Provide out-of-control vehicles with an escape route off the highway into a medium that will provide sufficient drag to help bring the vehicle to a standstill. Best material for beds is lightweight, smooth round ~10mm gravel or aggregate.	<p>A Dramatically reduce potential for serious crashes, particularly involving heavy vehicles..</p> <p>A Low maintenance.</p> <p>D Requires additional land-take.</p> <p style="text-align: right;">MEDIUM COST</p>
	High friction surfacing 	Used at approaches to junctions, pedestrian crossings & where drivers often need to brake sharply. Aim is to increase road surface friction in order to assist emergency deceleration by reducing likelihood of skidding. Usually an artificial aggregate bound to the surface using an epoxy resin.	<p>A Reduces the number of pedestrian vehicle collisions.</p> <p>A Resins used in the surfacings can be coloured easily giving added benefit of a visual signal to drivers.</p> <p>D Generally hard wearing but dependent upon quality of application and traffic levels</p> <p style="text-align: right;">MEDIUM COST</p>
	Improving skid resistance 	Used at areas of worn slippery surfacing. Replace worn surface with better friction surfacing, by surface dressing or by retexturing. Measurements can be made using the TRL Skid Resistance Pendulum and for surface texture, the sand patch test (see figure)	<p>A Can reduce the number of collisions.</p> <p>A Can be cheaper solutions than high friction surfacing</p> <p>D Not as effective as high skid resistance materials</p> <p>D Surface dressing least durable and susceptible to poor application</p> <p style="text-align: right;">LOW / MEDIUM COST</p>

6.3 Examples of education, training and publicity solutions

6.3.1 Road Safety Education (RSE) in schools

As discussed above, the student workbooks of individual lesson materials should contain many illustrations, and the illustrations should reflect the traffic conditions found in the city or urban area where the children live. The lessons should encourage 'self discovery' learning in a safe environment and should also include some direct roadside training.

The lessons for Primary School might cover such topics as

- Walking along the road,
- Crossing the road,
- Wearing seat-belts
- Traffic signals,
- Safety in cars,
- Road dangers
- Riding bicycles.

The teaching can involve children making posters. More 'practical' (ie out of classroom) resources are sometimes provided, such as a small-scale road network (with models, made by the children, of traffic signals, road signs, etc) that the children can walk 'in'. However, research suggests that real roadside lessons (on quiet roads) have greater benefits in changing actual behaviour. 'Pre-school' or 'after-school' programmes such as traffic clubs are organised in a number of countries.

For Intermediate and Secondary schooling, the topics might include

- Safety belts
- Accidents
- How to use the road
- How to drive safely (*note this is in 'theory' only*)
- Simple first aid
- The rules of the road
- Dangers of traffic
- Child seats
- Speed kills

Video materials on road safety that are suitable for use in class-rooms are often provided by private sector organisations. Programmes of regular school visits on a structured basis by specialist Traffic Police officers are frequently arranged. Such talks should not be to the whole school but to classes and tailored to the class age. In some cities, hospital visits for children to see and talk to road accident victims have also been included as part of a programme carried out in conjunction with the Traffic Police.

The amount and quality of the RSE depends to a great extent on individual teachers, some being more motivated than others, and upon the course books and lesson guides provided. Some limited teacher training in road safety and first aid teaching at educational colleges is increasingly recommended. This can be particularly valuable for designated lead teachers (safety 'champions') in schools. It should include ways to utilise parents and communities to reinforce RSE teaching.

Whether it is talks by the Traffic Police or lessons by teachers, they should be based on detailed accident analyses to identify and target actual problems.

6.3.2 Training

All road users need to be trained to deal with the types of hazards they will encounter while using the roads. This is true for pedestrians (whether child or adult), cyclists or drivers (of cars or lorries). Child 'training' is normally considered within the framework of road safety education (RSE) and has been discussed above.

In practice the training a driver receives (and is prepared to pay for) is dependent on the testing regime he will encounter to obtain his licence - and not the other way around. As a result, the training a driver undertakes can be influenced by the test. In many countries, it is compulsory to have some professional training; and even in countries where it is not compulsory (such as the UK) most learners are normally prepared to pay for some professional training to teach them how to pass the test - rather than to drive in the same way as their 'trainer' (who is likely to be a member of the family or a close friend).

However, in nearly all countries, newly qualified drivers (especially males) have a worse safety record than more experienced (and older drivers). Reasons suggested for this are: they are deficient in 'higher order' perceptual skills (e.g. hazard perception), lack experience in dividing their attention between ongoing tasks such as driving, navigating and talking to passengers (which is not normally part of the test). Sensation-seeking or peer group pressure to show off and drive fast are also likely to be factors.

Some countries try to reduce the novice driver problem by imposing restrictions on the vehicles they can drive, the speeds they can go, and even when they can drive (e.g. not at night when they are likely to be out with their friends). The use of probationary plates (to indicate a new driver) is sometimes compulsory - although sometimes they are just used by new drivers until they feel more confident.

It is important that driver training (and testing) provides the skills necessary to deal confidently with the driving environment they will encounter. However, it is recognised that 'passing the test' is only an early step in 'becoming a good driver'.

It is also widely recognised that drivers quickly stop driving in the same careful way they did on the test and while with their trainers. A newly qualified driver is generally well aware that he should wear a seat-belt, not exceed speed limits and that he should signal before manoeuvring - unfortunately in many cases this knowledge is simply ignored. Hence the need for publicity and enforcement programmes to reinforce good behaviour.

6.3.3 Mass media publicity programmes

Publicity campaigns are a major way of increasing public awareness of safety problems and providing information to change attitudes and influence behaviour to improve safety. They can be used to communicate with the general public about the introduction of new regulations (eg seat-belt wearing or compulsory insurance) or to persuade them to behave more responsibly and safely (eg not to speed). They can take many forms from 'adverts' on TV to handing out leaflets or using posters to transmit the message. In addition to this type of campaign - that has to be paid for - it is possible to make use of free ('below-the-line') methods such as newspaper editorials and stories, that can increase the public awareness and appreciation of issues.

The following are some general principles in designing and running road safety campaigns

- Campaigns should be direct and targeted, based on analyses of accident statistics.
- They should be conducted in conjunction with strong enforcement activity.
- Publicity specialists (professionals) should be used in developing the campaign - in designing the messages, materials and choosing appropriate media.
- They need to take count of social, cultural and motivational (eg attitude) factors in developing effective publicity campaigns
- At all costs, avoid such messages as 'drive safely'; rather say how this is done
- Use messages to say what to do rather than what not to do.
- Information should be collected on appropriate communication channels (eg TV programmes watched, magazines read) and used in running the campaigns.
- Campaigns should be evaluated

Campaigns are normally paid for by government but sometimes they may be "sponsored" by the private sector. Campaigns can make use of a range of media including: TV, radio, newspapers, press editorials and news reports, magazines, movie displays, green sites (digital video displays), leaflets and billboards. They can also use direct contact with the public through symposia, meetings, school programmes, competitions and quizzes.

Some countries put campaign messages beside the road side e.g. that remind the drivers of punishments that will be imposed on them for exceeding the speed limits. Research has shown that roadside posters warning of dangerous behaviours (eg. speed) erected by the roadside can have some safety benefits (Simmonds et al, 1981).

Many countries organise Traffic Safety Weeks but their value is debatable. A structured programme of road safety campaigns throughout the year is considered more effective.

In some cities and countries, driver behaviour is so poor that a dramatic change of driver appreciation, understanding and attitudes is required. This will not be easy to achieve in the short term since it involves 'engineering' a shift of behaviour for the majority of drivers – rather than just a few who behave irresponsibly. In such situations, there is a need to change behaviour that is engaged in (and accepted) by most drivers. The use of well publicised and highly visible automatic enforcement, such as speed cameras, may have to play an important role in bringing about significant change.

Drivers need to be made more aware of their personal responsibility for the social and economic costs of accidents, both to their families and other members of society. Injuring (or killing) children and causing permanent disabilities (rather than 'simply' killing people) have been used as powerful road safety messages in some countries.

6.4 Examples of traffic police enforcement solutions

6.4.1 Speeding, red light enforcement and other violations

Speeding and red-light violations are particular problems in many cities, to the extent that in one country it has been proposed that religious leaders issue teachings against them. Traffic police have developed various strategies and tactics for tackling speeding. As an example, speed enforcement might be carried out using marked cars as a high profile activity at peak times to maximise the impact on the driving public. Another strategy is to advise drivers of the locations of camera speed enforcement checks by signs and other publicity. Such measures should take place where the officers know there is speeding and speed related accidents from analyses of accident data. There should also be post evaluation of the effect of enforcement.

6.4.2 Poor overtaking/Aggressive driving/Close following

These types of violations are usually dealt with by police officers using observations with marked and unmarked police cars working together. In-car video cameras can be used to record this type of offence. Best practice is then for the violator to be stopped and the film of his driving played back to him to show the manner of his driving. This has been found to be an effective way of changing driver behaviour.

6.4.3 The use of technology

With the rapid advance in recent years of digital electronics and cameras, and the fall in costs, it has become possible for most traffic police forces to use this technology to assist them in their enforcement duties. Speed enforcement cameras – mobile and fixed - and red light enforcement cameras are now used in many towns and cities. It is common practice for a margin of 10% to be allowed before a violator is stopped and issued with a violation for a speeding offence.

'Intelligent' cameras are also being introduced that can switch between the following modes:

- Red light only
- Red light and speed
- Speed only

Some camera systems can also detect a vehicle approaching a green light that is about to change phase, and can hold the red light for the stopped traffic on opposing arms of the junction to prevent early release of this halted traffic. This is for situations which would otherwise be likely to result in very heavy braking by the approaching driver or red light running.

If a computerised traffic management system has been installed, this can help in identifying the location of accidents and allow the police control room to arrange diversions. A number of police forces are experimenting with the use of Global Positioning Satellite technology (GPS) to allow the control room to identify the police resource nearest to the accident/incident. This should improve the response time and allow the accident/incident to be cleared more quickly and therefore reduce the need for diversions and delays. The use of Radio Direction Finding (RDF) radio messages to advise police drivers about accidents, delays or diversions is used in a number of countries. The use of Variable Message Signs (VMS) to re-route and advise traffic is another development in a number of cities.

The use of Automatic Number Plate Recognition (ANPR) is another technological advance that is being tried to improve in-car enforcement tactics when operated.

6.4.4 Penalty point system

Despite significant efforts to increase enforcement of traffic violations, in many countries they continue to present a problem. The penalty point system has been introduced with apparent success in a number of countries. The system is designed to classify the violation proportionate to the degree of danger caused or likely to be caused. It identifies punishments that will be applied, including temporary or permanent withdrawal of driving licence and driver rectification training.

The penalty point system is based upon an offender reaching a maximum number of points, at which level sanctions are implemented. Usually, an offender can accumulate maximum points on a number of occasions but on each occasion the sanctions become more severe. Finally, the driving licence is suspended for life.

6.4.5 Roadside safety checks

Road safety checks (seat belt wearing and vehicle maintenance) are usually conducted at appropriate sites that give a high profile. This can require at least two marked police vehicles. Signs should be used on the approach to the site to maximise the message to drivers that a road safety check is ahead. Sites are best chosen that prevent approaching vehicles from turning around and avoiding the check. This practice can be an effective way of influencing driver behaviour and attitude.

6.4.6 Defective vehicles

It is standard practice in many countries when a vehicle is stopped and found to have a defect (e.g. defective brakes), the driver is given a violation ticket and then the vehicle is impounded by the police. The driver is then required to have the vehicle repaired in the pound and once the repair has been effected, the vehicle is released by the police.

Whilst this is an effective system, the Vehicle Defect Rectification Scheme (VDRS) system avoids the necessity for police to store defective vehicles in a car pound. The driver is issued with a defect notice. He then has to take his vehicle to a testing station to have the vehicle examined or repaired before the defect notice can be removed. A tester will examine the vehicle and verify it has been repaired by stamping the document with an embossing stamp and completing the relevant section of the form. The owner then returns the form in the manner instructed on the document to the Police force that issued it or, alternatively, produces evidence that the vehicle has been scrapped.

6.5 Changing behaviour through insurance schemes

Most countries require drivers to have at least 3rd party insurance. The cost of such insurance can serve to both reward safe behaviour (e.g. offer a 'no claims' discount) and punish unsafe driving (e.g. charge higher premiums for accident involved drivers).

This reinforcement regime is a typically long-term mechanism for improving behaviour (and safety) since it is based on accident involvement. It may be an option to consider amplifying the mechanism by taking account of things other than accidents such as violations and penalty point records.

7 THE FINAL DESIGN AND IMPLEMENTATION PHASE

In the previous stage, two major steps were taken: (i) agreement was made on the general strategy to be adopted for the programme of countermeasures; and (ii) plans were drawn up for the countermeasure programme itself. This included the selection of the general types of countermeasures to be installed. This chapter discusses the next phase in the USM process in which, firstly, the final designs for the countermeasure are drawn up and agreed; and then, secondly, the installation stage itself is carried out, with all the attendant publicity, site supervision and co-operation between agencies that this requires.

7.1 Designing measures for the solutions

Detailed highway design is beyond the scope of this Guide. This is likely to be carried out by a different unit to that investigating the problems; if this is the case, then the accident investigation team should remain actively involved with the designers throughout the design process.

7.1.1 Safety and Poverty Conscious design

In selecting the designs, and in later auditing of the designs, the principles of Safety Conscious Design, as discussed in Section 2.1, should be borne closely in mind.

Principles of Safety Conscious Design

- *Design for all road users*
- *Segregate wherever possible, integrate where not*
- *Safety in details of design – ‘Forgiving Design’*
- *Consistency of design*
- *Meet drivers expectancies – if not, alert the driver physically or with noticeable signing*
- *Prevent Discourage drivers from behaving badly*
- *Encourage appropriate speeds*
- *Be aware of human limitations – they are always making errors*

Figure 7-1: Principles of Safety Conscious Design

In addition, any special needs of the urban poor identified in the analysis and strategy phases must also be at the forefront of the designers mind, as for example pedestrian or cycle routes, or special facilities for slow moving animal drawn vehicles.

7.1.2 Legal issues

The designs should also be checked for any possible legal problems that might be encountered. The relevant road traffic regulation act should be consulted. This should specify how the police and other organisations should be formally consulted, how the traffic regulation orders should be advertised and how any objections are to be considered.

In some countries, special provision has been made for experimental designs. For example, in the UK an experimental order can be introduced without advertisement or consideration of objections. When the experiment has been in operation for at least six months, a permanent order can be advertised and brought into operation. The public then has a further six months in which to make objections, which are considered in the normal way. However, whilst a willingness to experiment in exceptional circumstances is likely to be good for public relations, an appearance of continual changing of design might undermine public confidence.

7.1.3 Further consultation

A further round of consultation should then take place checking that the designs are acceptable to as many people as possible. If a scheme is found to be controversial, the authority should consider the possibility of introducing it as an experiment, again ensuring that any legal requirements are met.

7.2 Road safety audit

Road safety auditing should be an integral part of the design and implementation process. This section gives a brief introduction to the process. Full discussions can be found in IHT, (1990), Austroads, (1994), PIARC, (2001) and Proctor et al , (2001).

7.2.1 The need for road safety auditing

Road safety audit is a means of accident prevention rather than accident reduction (a change in philosophy to the previous chapters). It is the application of safety experience to the design process to ensure that future safety problems are not **designed in** to new schemes. It is discussed here because ideally an audit should also be carried out at this stage of the USM process:

- at the design stages; and
- immediately after the scheme implementation; that is, prior to opening to normal traffic.

Safety audit is simply the technical term for the systematic checking of safety aspects of new schemes carried out on the public road.

Although it is assumed that national standards will be followed in any design unless unusual local conditions dictate a departure (which may need special approval), experience in many countries has found that a combination of elements perhaps close to their respective recommended minimum standard, may combine to create safety problems. Safety audit seeks to address such problems.

7.2.2 Aims of the safety audit

- To ensure that all road schemes operate as safely as possible.
- To ensure that preventable potential accident-generating elements are not included in a completed scheme; for example, lamp columns close to the edge of the carriageway (should be located at the back of the footway).

- To ensure suitable accident-reducing elements are included in the scheme, for example, "anti-skid" surfacing on downhill approach to traffic signals, guard rail and chevron boards on an unavoidably sharp bend, crash cushion before an essential solid structure.

7.2.3 Organisation of the audit

In a road authority it is likely that safety audit will be carried out within the accident investigation/road safety unit, though preferably by more than one person. Before deciding on who should carry out the audit the following should be considered:-

- The audit team should be independent of the design team. It should contain (and must certainly be led by) persons with safety engineering experience. A knowledge of design standards is important.
- Other specialists such as traffic signals and structural engineers may also need to be consulted depending on the scheme. The police may also be required, particularly in the latter stages of the audit, where special road users' requirements may need consideration.

An arbitration procedure should be agreed in case of differences in opinion.

7.2.4 When to carry out the audit

Safety audits can be performed at the following stages:

- feasibility study
- completion of preliminary design
- completion of detailed design
- prior to opening to traffic
- other times on an informal basis

7.2.5 The audit task

Information such as plans, list of standards followed, departures from the standards during design, traffic and pedestrian counts, and accident records should be collected from the design team. It may be helpful to discuss the purpose behind the design of the scheme and it is essential to carry out a site visit at all stages of the audit.

Appropriate check lists (IHT, 1990; Austroads, 1994) should be used to systematically ensure no safety problem is overlooked. However, the audit team should not rely solely on these lists but should utilise their experience.

The auditors should imagine "walking" or "riding" the scheme on a bicycle, and should physically do this at the final audit stage to check, for example, that signs are of the correct type and in the right place, road markings and traffic islands are correctly placed and that there are no unforeseen conflicts between the treatment and other existing site features.

Although the audit team should discuss their findings with the design team, a formal report should always be produced. This should state the potential safety problems as precisely as possible and should include a recommendation or options for

improvement. The recommendation should be in outline form only and it may be desirable to annotate copies of the original scheme drawings.

The scheme should be monitored and feedback given to the design team.

7.3 Implementation

7.3.1 Staged implementation

It is generally recommended that the measures be implemented in stages. This will minimise disruptions and with this step-by-step approach, any unforeseen difficulties can be ironed out and lessons learnt for subsequent stages. For the morale of the team, it is valuable to begin with a 'quick fix' to a big problem - a successful start can lift the team and produce a momentum that will benefit the rest of the programme.

7.3.2 Experimental installation

If there is any doubt about the benefits of the scheme, it is often first tried on an experimental basis, using blocks, cones, sandbags etc for temporary islands or channelisation. All relevant road marking and signing should still be installed.

7.3.3 Publicity

As soon as the final decision to go ahead is given, leaflets or similar publicity should be distributed to local residents and businesses allowing them to ask questions about the final details. Appropriate suggestions on street furniture, materials or planting should be incorporated. On a wider scale, information should be given through the media about the accident problems of the area and the aims of the scheme. This is particularly important at the implementation stage.

7.3.4 Safety at roadworks

Accidents tend to occur at a higher rate at roadworks sites and involve more vehicles than on normally operating sections of the road network. Studies have shown that even in developed countries where a relatively high standard of prescribed advanced warning sign layout is generally followed, roadworks can have almost twice the accident rate, and as many as a third involve four or more vehicles.

It is very important, therefore, that countermeasure installations themselves are made as safe as possible. The road engineer must ensure that contractors erect temporary signs at their roadworks sites. Often with relatively short-term work, warning signs are not set out sufficiently in advance of the works site or are too few in number: this is particularly hazardous where drivers' vision of the site may be obscured by a bend or other traffic.

The use of modern electrically-powered flashing arrow lights mounted on trailers tend to provide a more effective means of attracting drivers' attention.

Attention should be paid to the use of adequate lengths of "safety zone" or "buffer space" which provides an escape area if drivers fail to notice the advance warning signs and protects the men in the work area.

In many countries, it is recognised good practice to protect road works with tapers of traffic cones to close off a lane gradually before the work area, or to move traffic into other contra-flow lanes. In a number of countries, this practice is often not used at all and in others the tapers are often far too short.

7.3.5 Final safety audit

A final safety audit by an independent safety specialist just before the works are completed is particularly important.

7.3.6 Opening the scheme

Ongoing discussions with the traffic police should have established what levels of additional policing should be allocated for the first few days of the new scheme, and the manner and degree of enforcement that should be applied. Further press publicity should also be arranged.

The first few days any new scheme is opened can be crucial to the public perception of its success or failure. The USM team with the traffic police should be on site watching how road users react, and fine tuning the scheme if at all necessary with cones, sandbags, signs etc.

7.3.7 Implementation log

It is important to keep a record of the precise dates of the beginning and completion of major parts of the remedial work for all jobs. This is essential for the monitoring of the scheme (see following chapter).

Similarly, details of all costs involved, including variation orders, must be kept. The actual costs often differ considerably from original estimates, and this record will facilitate a more reliable cost-benefit analysis.

8 ASSESSMENT: MONITORING AND EVALUATION

Monitoring a scheme is concerned with the effects of the scheme from the first few days, weeks and months, and then continues until a full evaluation is undertaken, normally after two or three years.

8.1 Monitoring

8.1.1 The first few days and weeks

Perhaps the most important monitoring is conducted in the first few days of any new scheme. As indicated in the previous section, this period can be crucial to the public perception of the success or failure of the scheme. The USM team with the traffic police should spend much of their time on-site observing how road users react, and fine tuning the scheme, if necessary, with cones, sandbags, signs, etc.

In the first few days and weeks of a scheme, the team should be wary of two effects that can occur that are almost opposite in nature:

1. There may be a rise in minor accidents as road users re-adjust to the new circumstances, but then these should then hopefully decline to levels below the previously existing levels. If there is any sign of an increase in serious injuries, the team should consider abandoning or radically modifying the scheme as quickly as possible.
2. An opposite effect can also occur - early results are often very encouraging, but the benefits can be found to reduce with time. This may be because most innovative measures tend to have a novelty effect, or because road users initially take extra care because of their unfamiliarity with the new layout or design.

It is possible to speculate that these two particular effects may depend upon how apparent the changes are to the road users; the first effect possibly due to the visual changes being rather subtle, and the second due to the visual changes being very apparent.

8.1.2 Repeated Surveys

After suitable periods, say one, three and six months, the various 'before' studies (eg. speed, flow, conflicts) should be repeated, and roadside/household/business interviews carried out. These will lend weight to any argument for making further changes at the site or, indeed, proving success. Once again, if any serious problems are identified from these studies, the team should respond rapidly. It can happen, for instance, that some feature of a scheme may produce an unforeseen reaction in drivers, which creates a potentially hazardous situation. Monitoring should highlight this problem at an early stage so that appropriate action can be taken quickly to remove this danger. If such a problem is identified it may be possible to alleviate this danger easily; for example, by a realignment of kerb lines. At worst, it could lead to the complete withdrawal of a scheme and the need to reassess alternative schemes.

8.1.3 Monitoring accidents

As indicated in section 2.2, software is available to assist in the monitoring of accidents and casualties over the scheme areas and sites. The schemes should be

checked after 3 monthly periods (3, 6, 9, 12 months etc) and the data carefully examined for any problems not spotted from the site studies and interviews.

It is essential to carry out the monitoring effectively, not least to avoid the "bad publicity" which could occur if a road safety scheme was seen to be actually **causing** accidents by making the situation worse than it was before the work was implemented.

A simple visual method for monitoring accidents that is commonly can be used is that of cumulative accident number plotting. In this method the number of accidents (and types if required) are plotted, together with their cumulative mean, for the period before the works were done and for the period after. This method is perhaps more suitable for mass action plans or USM projects rather than single sites due to the number of accidents involved.

Table 8-1: Motorcycle (m/c) accidents in pilot areas of 'running headlight' campaign, Malaysia

Collision type	Jan	Feb	Mar	Apr	May	Jun	Jul	Aug	Sep	Oct	Nov	Dec
MSTOX* daytime accidents	68	48	79	44	61	73	53	43	38	49	40	68
Cumulative MSTOX accs	68	116	195	239	300	373	426	469	507	556	596	664
Predicted cumulative mean MSTOX accs	68	130	192	255	317	379	441	503	565	628	690	752
All m/c Night-time accidents	17	16	28	11	15	20	23	13	13	21	17	26
Cumulative Night accidents	17	33	61	72	87	107	130	165	165	186	203	229
Predicted cumulative mean Night accidents	17	35	53	70	88	106	124	160	160	177	195	213

*MSTOX = m/c moving straight or turning when other road-user crossed their path

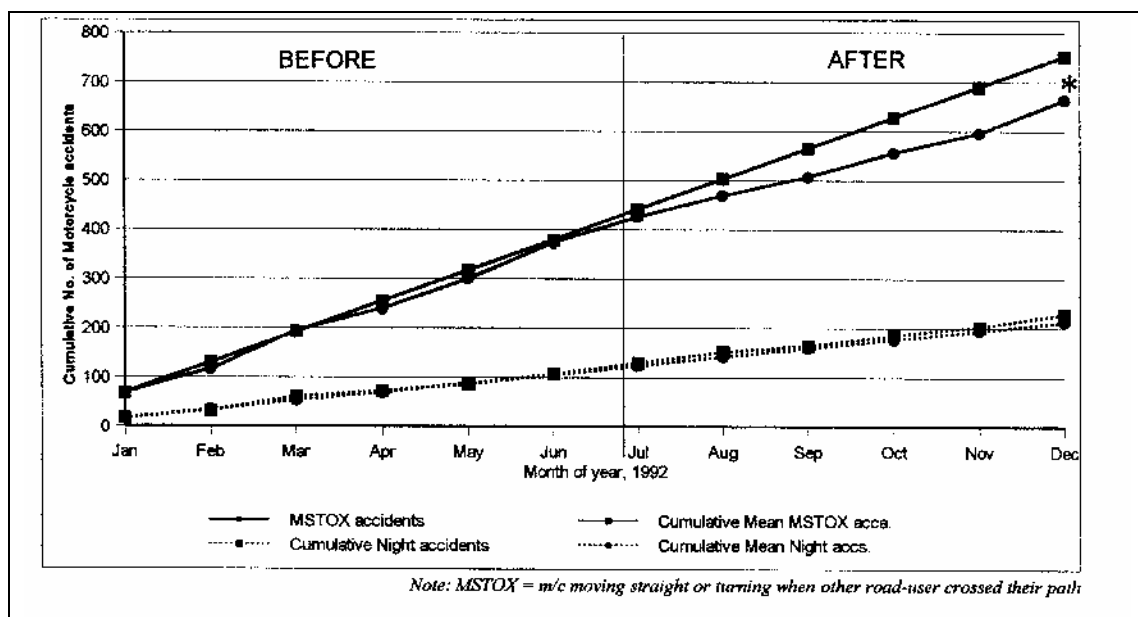

Figure 8-1: Motorcycle accidents in pilot areas of 'running headlight' campaign

Figure 8-1 (from Radin et al, 1995) is an example of this method of data presentation, and illustrates that the daytime running headlight campaign in Malaysia was apparently being effective in reducing those accidents related to daytime conspicuity (MSTOX = motorcycles moving straight or turning when other road users cross their path), whilst having no effect on night-time accidents. In Table 8-1, the predicted cumulative mean number of related accidents has been calculated as follows. The first month value for the predicted cumulative mean is merely the first month total of accidents in the before period. The predicted cumulative mean figure for each month after this is then calculated by adding **the monthly average of the whole before period**, to each month throughout the period. This can be continued through the after period. As long as the standard deviation is not large, the two lines of cumulative accidents and predicted cumulative mean accidents lie close together during the before period. After implementation of the scheme the predicted cumulative mean line represents what would normally be expected if no action had been taken. The cumulative number of accidents happening in the after period is also plotted and the amount the two graph lines drift apart (marked * in Figure 6-1) represents the accidents saved by the measure.

However, to be sure that the random nature of accidents has been taken into account, it will normally be necessary to wait for several years for a full evaluation to be carried out (see section 68.3). The above method is useful for drawing interim findings when more immediate feedback is necessary. Other behavioural data, as mentioned in the section on Initial Observations can also be collected to give indications whether a scheme is working.

8.1.4 Effects on other areas

It is important to examine whether the scheme has led to an increase in accidents, traffic speeds and volumes in adjacent areas. The possibility of 'accident migration' is discussed in section 8.3.3

8.1.5 Logging the monitoring measures

Recording the results of the monitoring measures is also important to build up a database of types of treatment and the effects they produced. This will provide information for future safety engineering work.

8.2 Before-and-After Studies

Before-and After studies are one of the basic tools for monitoring and evaluating road safety schemes. Many *Before* measurements will have been made during the Problem Analysis phase of the USM project. It must be noted, that the behavioural or geometric variables carried out in these surveys (see Chapter 24) have the disadvantage that they do not give a direct measure of the magnitude of safety improvement since the precise relation to accidents is uncertain. However, despite this drawback objective measurements are often considered very worthwhile since they can give a good indication of a change in safety.

8.2.1 Timing of the *Before* measurements

There can often be a significant delay between the Problem Analysis phase and the Implementation phase. Ideally, *Before* measurements should be made as close as possible to the time when the scheme is implemented, and this may therefore require some repeating of earlier measurements. Ideally, this would be during the month before (except for accident monitoring - see paragraph Section 68.1.3). It should be

remembered that *Before* monitoring *can never be repeated*. It is important, therefore, to check *Before* data before a scheme is installed.

8.2.2 Timing of the *After* measurements

Measurements should not be taken during the installation period. Additionally, after installation, a week or more should be allowed as an adjustment period for road users to become familiar with the new scheme.

As suggested in section 8.1.2, '*After*' measurements should commence within one month of site work being completed. It is often desirable to take several sets of *After* measurements, at various time intervals after the scheme is introduced, to investigate the extent to which any initial effect is sustained and to allow for seasonal variations.

Where possible, monitoring should take place under 'normal' traffic conditions and not coincide with, for example, school and bank holidays, market days, early-closing days, poor weather or roadworks.

Where data are to be compared between sites, it is useful if all monitoring can be carried out at the same time, or if careful cyclic monitoring techniques are planned in the design of trials. If several schemes with different installation periods are involved then consideration could be given to planning equivalent monitoring periods with respect to installation dates.

8.2.3 Changes in the *After* period

It would be disappointing, to say the least, if there was not an immediate and noticeable improvement in driving behaviour at a scheme (e.g. particularly a reduction in speed in, say, a traffic calming scheme). What is more important, however, is that a worthwhile underlying improvement (that results in casualty savings) remains after any initial novelty effect has worn off. It is this underlying improvement which is the most important to measure. Experience from earlier research suggests that changes in behaviour should have stabilised by three months after installation and this is, therefore, recommended as a suitable period to judge the value of the scheme in behavioural terms.

Whilst the ultimate measurement to consider is the effect of the scheme on accidents and casualties, many schemes (e.g. traffic calming) are designed mainly to achieve reductions in vehicle speed although, given the now well-proven correlation between speed and accident reductions (Taylor et al, 2000), one might reasonably expect accidents to be reduced also. However, when monitoring only one scheme or a small number of schemes over a short time, accident monitoring alone will only be a weak indicator, as it is most unlikely that small numbers of accidents and short time-scale of the monitoring will allow any changes to be statistically significant. Thus, behavioural changes may be the best predictor of benefits at this stage of monitoring.

8.2.4 Control data

In most of the monitoring measures (and particularly accident changes) it is necessary to take into account other factors not affected by the treatment which might also influence that measure. Examples are: a change in speed limit on roads which include the site; national road safety campaigns; traffic management schemes which might affect volume of traffic.

These changes may be compensated for by comparing the same "before" and "after" periods with accidents (or other measurements) at "control" areas which are untreated. Control data can be either matched pairs or area controls.

A matched pair control area should be similar to the treated USM area in general characteristics and also geographically fairly close to it (but not close enough to be affected by any traffic diversion). This is so that the control will be subject to the same local variations which might affect safety (e.g. weather, traffic flows, enforcement campaigns).

Although the matched pair is the best statistical method to use, in practice it is very difficult to find other sites with the same problems which are left untreated purely to carry out statistical tests. Area controls which comprise a number of sites are, therefore, much more frequently used.

When choosing the control areas:-

- it they should be as similar as possible to the treated USM area;
- it they should not be affected by the treatment;
- ideally it in total they should have more than 10 times the number of accidents of the treated USM area.

For example, if the traffic signals in an area are modified then the control area might be all other signalised sites in the town. But if the control area is relatively small and has few accidents, then it would be better to use all signalised junctions in the regional area (e.g. province, county or Statestate).

8.2.5 The statistical techniques

The statistical techniques involved in a full before-and-after analysis of accidents are discussed in Appendix B.

8.2.6 Conflict studies

Traffic conflicts are observable 'near accidents' that can be used to provide a fast assessment or evaluation of safety measures. They occur when a road user has to take avoiding action (eg by swerving or braking) to prevent an accident taking place, and can be graded by the severity of this action. They can be counted by small teams of observers (or even individuals) and serve as an accident surrogate. They were actively studied in developed countries some years ago (Asmussen, 1984) to provide a rapid evaluation tool - and to replace supplement long-term accident studies. However, the use and training of suitable observers proved costly there were problems with validating the technique - in developed countries - and they are no longer widely used.

In spite of this it was felt that they might serve a useful role in developing countries, especially if the technique could be simplified (for example, by avoiding an overly complex classification of conflict types).

As a result a very small pilot study of the conflict technique - suitably modified (ie simplified) for use in developing countries - was tried in one of the studies. The findings are reported in Annexe 2.

8.3 Evaluation

This section emphasises the need to evaluate the changes resulting from the USM scheme, particularly with respect to the fundamental measure of safety, and to justify the expenditure made to produce these changes as this may influence future

decisions on improvements. It therefore concentrates on accident changes and describes the simple statistical tests needed to explain the results obtained.

8.3.1 The purpose and scope of evaluation

The full safety evaluation will normally take place two or three years after the implementation. The objectives of the evaluation are to:

- Assess the effects upon accident occurrence in relation to the safety objectives
- Assess the effects upon the distribution of traffic and speeds of motor vehicles in the area
- Call attention to any unintended effects on traffic movements or accident occurrence
- Assess the effects upon the local environment
- Learn of public response to the scheme in terms of its acceptability in general and people's concern about safety in particular (IHT, 1991)

In analysing the accident data the team should examine:

- Before-and-after analyses using an area that includes the scheme itself and adjacent areas that may have been affected by the scheme. At least two years and preferably three years of data should be used for both the before and after periods
- The change in accidents over the before and after periods for both the study area and a similar sized Comparison control Area areas in another parts of the city or town. It is possible that accidents have been reduced in both areas due to some external factor such as an oil crisis
- Detailed time series analyses over the before-and-after periods to see any unusual fluctuations, seasonal variations or other trends
- Analyses of accidents by road user group to see if there have been any differential benefits or dis-benefits
- Analyses of accidents by collision type to see if any type has significantly been reduced or increased by the scheme
- Any indication that individual measures were effective or ineffective, with a view to making recommendations for future designs.

The main assessment is then to examine the changes against the safety and other objectives set by the scheme e.g. the extent to which head-on or pedestrian accidents were reduced. Were traffic and/or speeds reduced along certain roads as predicted? Were any particular groups e.g. shopkeepers, particularly upset by the scheme, and did those concerns reduce over time as the road users got familiar with the scheme?

8.3.2 Evaluation of traffic speed data

The t-distribution can be used to compare whether any changes in the measured mean speeds in two periods of measurement are statistically significant (see Appendix B) or, indeed, whether there is a significant difference between the speeds of groups of different vehicle types. The same tests can be used for similar types of measurements of traffic like travel times, vehicle headways and pedestrian safety gaps.

If a particular scheme was actually intended to significantly change the speed distribution (e.g. to affect changes to the highest speed drivers only - to produce a markedly skewed distribution), then a Kolmogorov-Smirnov test would be appropriate (Appendix B). This is a powerful non-parametric test applicable for analysis on distributions that are not Normally distributed.

8.3.3 Factors affecting accident frequencies

The most significant step of the evaluation procedure is determining whether the treatment has been successful in achieving its objective of reducing the number of accidents. This therefore requires Before-and-After studies (see section 8.2). This Guide does not attempt to delve deeply into the different statistical techniques that need to be applied, but does suggest practical and simple ways in which schemes can be evaluated. There is a basic assumption in Before-and-After studies that a similar pattern of accidents to the 'before' period would have occurred in the 'after' period if nothing were done. This is not necessarily the case. The main problem when using accident data for evaluation (even assuming high recording accuracy) is to distinguish between a change due to the treatment and a change due to other sources. Some of these other factors that need to be considered are discussed below:-

Changes in the environment

As discussed in section 8.2.4, a change in the environment or driving habits can affect the accidents occurring at the study site irrespective of the scheme implemented. For example, a change in the national speed limit for the class of road at the site, or closure of a nearby major junction to the area producing a marked change in traffic patterns.

This feature can be taken into account by the use of control area data but for this to be valid it is important that these areas experience exactly the same changes as the site under evaluation.

Random fluctuation

The relatively rare and random nature of road accidents can lead to quite large fluctuations in frequencies occurring at an individual site from year to year, even though there has been no change in the underlying accident rate. Over an area such as that of a typical USM scheme, these variations are less marked but remain an intrinsic factor. Tests of statistical significance are therefore generally necessary to determine whether the observed change in accident frequency is likely to have occurred by chance or not (see section 8.3.5).

Regression to the mean

This effect complicates evaluations most particularly at high accident or blackspot sites. Accidents at these sites tend to reduce even when no treatment is applied. Even if a 3-year total is considered at the worst accident sites in an area, it is likely that the accident frequencies were at the high end of the naturally occurring random fluctuations, and subsequent years will yield lower numbers. This is known as *regression to the mean*.

Table 8-2: Injury accidents at 122 nodes or junctions in a town

No. of injury accidents per site in 2000	No. of sites	Total accidents in 2000	Total accs. at same sites in 2001	Change in accidents (uncontrolled)
9-10	1	10	6	-40%
7-8	2	15	10	-33%
5-6	6	32	20	-38%
3-4	17	61	68	+12%
0-2	96	76	119	+57%
Totals	122	194	223	

As an example consider Table 8-2 **Error! Reference source not found.** which gives the actual numbers of recorded accidents involving personal injury for 122 nodes in a particular town over a two-year period. For sites with 5 or more accidents in year 1 there were overall fewer accidents in the following year. Conversely, sites with four or less accidents have more accidents in year two. If an accident countermeasure had been installed at the worst 9 sites at the end of year 1 then a highly significant reduction of 37% might be claimed after year 2, even if the measure had been completely ineffective (this same result would be obtained by doing nothing). An even higher false result would be certainly have been obtained if the other 113 sites were used as a control group since this group experienced an overall increase in accidents.

Possibly the most straightforward way of allowing for both the regression-to-mean effect and changes in the environment would be to use control sites (or in the case of an USM project, a control area) chosen in exactly the same way as the treated sites, and identified as having similar problems, but left untreated. In practice, it can be both difficult to find matched control sites and, if investigated, to justify not treating them.

There has been much debate among statisticians over many years on this subject and the best way to deal with it (see: Wright & Boyle, 1987; Hauer et al, 1983; Abbess et al, 1981; Maher & Mountain, 1988; Kulmala, 1994).

The effect does, however, tend to be diminished if longer periods of time are selected. For example, Abbess et al (1981), in a study in two counties of the UK calculated that regression-to-mean had the following effects (Table 8-3) at high accident sites (ie. more than 8 injury accidents per year), on average, on their accident rate:-

Table 8-3

Period of accident data considered	Regression-to-mean change in annual accident rate
1 year	15 to 26%
2 years	7 to 15%
3 years	5 to 11%

Because a USM project is concerned with an area rather than a single site, the regression-to-mean effect should be of less significance, but the team should be aware of the possibility of it contributing to the apparent benefits of the scheme and some allowance should be made.

A more complete discussion of correcting for the Regression to the Mean effect is given in Appendix B.

Accident migration

There is still some controversy over whether or not this effect exists but it has been reported by several researchers (Mountain et al, 1992; Boyle et al, 1984; Persaud, 1987). It is simply that an increase in accidents tends to be observed at sites adjoining a successfully treated site giving an apparent transfer or 'migration' of accidents. It is unclear precisely why this effect occurs but is suspected that drivers are 'compensating' for the improved safety at treated sites by being less cautious elsewhere.

Obviously to detect such an occurrence, one needs to compare the accident frequencies before and after implementation of a scheme and those for the surrounding area with a suitable control group. However, research and practical evidence (eg. Brindle, 1986; Webster and Mackie, 1996) have demonstrated that local area traffic restraint schemes do not create a significant increase in accidents on surrounding roads. Mountain(1998) has more recently concluded that a more likely explanation for any observed increase is a reverse regression-to-mean effect arising due to bias in the selection of the neighbouring sites.

Behaviour Adaptation

The effect of road users tending to alter their behaviour following introduction of a new safety improvement, is now generally more accepted than the original, more controversial, philosophy of 'risk compensation' or 'risk homeostasis theory'. The latter suggested that road users maintain a fixed level of accepted risk, and so will take more risks when given greater accident protection, for example, by seat belts or anti-lock brakes.

However, Trimpop and Wilde (1994) concluded that accidents are not necessarily the result of risk-taking desire, but more of an inappropriate action based on faulty risk assessment. Thus the challenge for the road engineer is to introduce schemes that minimise the chances of road users making faulty assessments; for example, in ensuring consistency in road users' expectations for the level of road surface friction, superelevation on bends, design of junctions etc. The engineer must be aware that drivers assess potential risks largely through visual perceptual cues and experience; and that he must avoid misleading architecture that can lead drivers into taking greater risks than they intended.

Grayson (1996) concluded that evidence that adaptive or compensating processes are seriously reducing the effectiveness of safety measures is slender and poses little threat to current road safety practice.

8.3.4 Before and after periods

There are a number of points to be taken into account when choosing periods to compare before and after the treatment was applied:-

Before and after periods at the *treated* site should be identical to that at the *control* site.

The period during which work was carried out should be omitted from the study. If this period was not recorded precisely, a longer period containing it should be omitted.

The before period should be long enough to provide a good statistical estimate of the true accident rate (so as to remove as far as possible random fluctuations). It should not, however, include periods where the site had different characteristics. Three years is widely regarded as a reasonable period to use.

The same applies to the after period which ideally should also be three years. However, results are often required much sooner than this. A one year after period can initially be used if there is no reason why this should bias the result (as long as the same period is used at the control sites). However, sensitivity is lost and the estimate of the countermeasure's success should be updated later when more data becomes available.

8.3.5 Standard statistical tests of applied to accident changes

In evaluating a treatment the answers to the following questions will usually be required:

- Has the treatment been effective?
- If so, how effective has it been?

It is assumed that the user of this Guide will need to interpret accident data practically without necessarily understanding the underlying statistical theory. For this purpose, in applying the standard statistical tests described below, it is sufficient to assume that the before and after accidents are drawn from a normal or Gaussian distribution.

This means that we can use the Chi-square test to answer the first question as to whether the remedial action has been effective, i.e. whether the accident changes at the site were statistically significant. The common way in which this is applied is described below. However, the size of that change may first be investigated by using the Tanner *k*-test.

The Tanner k test (magnitude of the change)

It is possible that although accident levels reduced at a treated site or area in an 'After' period, the general level of accidents is also reducing; the "real" reduction due to the treatment being *less* than the actual numbers observed (i.e. *overestimating* effectiveness). Conversely, if the general level of accidents is increasing, an *underestimate* of the treatment would be obtained. The Tanner *k*-test can be used to show how the accident numbers at a treated site or area change relative to control data (see Appendix B).

The Chi-Squared test (significance of the change)

The chi-squared test is traditionally used to determine whether a change in accidents is statistically significant or could have occurred by chance. The test makes certain distributional assumptions that may not strictly be appropriate when sites with high accident numbers have been treated (see discussion of the regression-to-mean effect in Section 68.3.3. Nevertheless it is easy to apply and is a good measure of whether the scheme was effective.

The test involves comparing data from the treated site or area with the untreated control sites by calculating the value of the statistic, chi-square, and looking this up in a table with the appropriate degrees of freedom to determine whether it has exceeded the appropriate table value (see Appendix B).

Test for statistical significance between two proportions

This test tells us whether the difference in the distributions of accident types in the study and control samples are significantly different from each other or if the difference is likely to have occurred by chance (see Appendix B). For example, it could be used to determine whether the proportion of accidents in the study area that involve cyclists is greater than expected (i.e. disproportionately large compared with the proportion of accidents in the control area that involve cyclists).

8.3.6 Economic evaluation

For every scheme, the evaluation should include an indication of the benefits actually achieved in relation to cost. Even if the scheme has been designed to tackle a very specific target group of accidents, it is normal practice to include all accidents at the site or area in a full evaluation - in case the measure has had the unforeseen effect of increasing other accident types.

The previous sections have already outlined how the best estimate of the size of the effect of a scheme (or group of schemes) on accidents can be determined. Some allowance should be made for the regression-to-mean effect.

First Year Rate of Return (FYRR)

If the evaluation period (for both *Before* and *After* periods) was, say, 3 years then the saving in accident frequency (per year) should first be calculated. The monetary value of these accidents is then calculated using the current accident costings adopted by the government of the country concerned figures. Highway authorities normally then calculate and quote the First Year Rate of Return to give a rough guide to the value of a scheme, i.e.

$$FYRR = \frac{\text{Value of annual accident savings}}{\text{Cost of scheme}^*} \times 100$$

*A more accurate figure would be obtained by including any maintenance costs in this year and also increased journey time costs if this is applicable.

Net Present Value (NPV)

In some cases it may be advisable to carry out an evaluation which expresses the difference between costs and benefits that may accrue over several years, e.g. particularly if the installation covers more than one year or there are known to be inevitable new maintenance costs in future years. This accrual needs to be against a common year price base.

In the Net Present Value approach there is a need to take account of money having a changing value over time because of the opportunity to earn interest or the cost of paying interest on borrowed capital.

The major factors affecting present value are the timing of the expenditure and the discount (interest) rate. The higher the discount rate, the lower the present value of an expenditure at a specified time in the future. If the discount rate for highways is 6% then \$1 of value this year, if it accrues next year would be valued at 6% less (i.e. 94 cents, and the following year 88 cents etc).

The overall economic effectiveness of a scheme is indicated by the Net Present Value (NPV), which is obtained by subtracting the Present Value of Costs (PVC, which must also be discounted if spread over more than 1 year) from the Present Value of Benefits (PVB). This technique is described in more detail with examples in RoSPA (1992).

8.4 Final consultation and reporting

After the final statistical evaluation, the team then needs to consider if there are additional measures needed to fully meet the objectives agreed in the planning stage. Having conducted a thorough appraisal of the scheme, the stakeholders should then be brought together again to inform everyone about the successes and failures, with appropriate press releases.

After this final consultation stage, a report should be prepared on the achievement of the objectives with recommendations for future USM schemes. In particular, draw attention to any future Local Area Schemes the analyses have identified.

8.5 Summary guidelines on evaluation

- Plan, and start, the evaluation process early
- Include the cost of the evaluation in the initial budget
- If possible have a 'control' area
- After implementation allow time for people to adapt to the changes
- Consider using both qualitative and quantitative methods
- Publish the findings of any evaluation (whether good or bad)

9 CONCLUDING REMARKS

The purpose of these Guidelines has been to introduce the concepts of Urban Safety Management to an audience of professional local engineers and other local authorities who have responsibility for road safety, traffic management and planning in towns and cities in developing countries. The intention is that they should adapt the procedures outlined here to their own needs and circumstances, perhaps adding or deleting stages of the process, or adopting radically different solutions to those illustrated here. This is because there can be marked differences both between countries and within countries in the traffic mix, road user behaviour and the road infrastructure found in urban areas. For many developing countries, introducing USM schemes in developing countries will necessarily be very different from the kinds of schemes currently being employed in developed countries. Firstly, they are often beginning from very different starting points; secondly, they may probably being introduced in an environment where 'other' rapid changes (such as motorisation) are also likely to be taking place; and finally, they may be proposed in areas where there is little public appreciation of traffic risk and the need for, and benefits of, safety management.

This means that a flexible and common sense approach needs to be adopted. For example, road hierarchy and land-use are likely to be much less well defined; at the same time, the mix of traffic (and domestic pets and other animals) and types of accidents encountered are likely to be much more varied. While this may complicate the preparation phase, it may simplify some of the decisions that need to be made; for example, banning rickshaws or non-motorised traffic from a particular road, or deciding that a particular area, such as around a market square, should be for pedestrians only.

The special needs of the urban poor have been focussed upon throughout the USM process, and these may well change the priorities within the strategy adopted. It is hoped that the application of USM, particularly if focussed on the needs of the pedestrian, will reduce injuries suffered by this already disadvantaged group and contribute to the wider goal of poverty reduction.

While the guidelines provide both an overall structure and series of possible measures to be used as part of the overall USM approach it is important that local practitioners bring their own knowledge and experiences into the project. There is little to be gained in 'importing' measures that might have been tried, and found to have failed, in the past. It needs to be recognised that solutions that work in one environment can fail miserably in another. Also, any scheme will depend critically on available funding, and often a compromise has to be made between the extent (and cost) of the proposed measures and the size of the area being tackled. However, there is little point in introducing a scheme that has a high probability of failure, since should it do so, this will provide support for those who argue that nothing can be done and thus encourage future inactivity - and the safety problems will probably continue to grow. It is far easier to remedy a worsening problem than to overcome one that has remained unchecked and already out of control.

One important fact that needs to be recognised – especially in developing countries – is that increased traffic safety is not an impossible goal, and the experience from many developed countries is that the ways of improving safety are known, even if they may not be simple or straightforward to carry out. In particular, it is important to consider that some measures can be successful and popular eventually with

practitioners, the public and politicians alike; and often for very different reasons. If this is not argument enough for attempting new ways of improving safety, then it is simply a case of imagining what the situation might become like in 10 (or 20) years time if nothing was attempted now to help remedy the situation. However, USM is only one of a number of ways of improving safety. Although USM itself can be considered a multi-sector approach, these particular guidelines focus particularly on low-cost engineering measures. However, the value of employing other measures based, for example on education and enforcement, must not be forgotten.

It is hoped that this manual will both inform stakeholders and encourage successful and innovative road safety activities in developing countries. It aims to prompt schemes, prompt experiment and prompt communication between groups with similar ambitions to make their urban environment a safer and healthier place in which to live, especially for the poor and disadvantaged.

For additional information on any procedure or countermeasure, the reader is invited to contact the TRL at International Division, TRL Ltd, Crowthorne, Berkshire, United Kingdom, RG45 6AU; or e-mail: international_enquiries@trl.co.uk



10 ACKNOWLEDGEMENTS

The authors would like to thank the Department for International Development for providing the funding for production of this Guide as well as the associated case study trials of urban safety management in Bangalore, India and Cirebon, Indonesia which have greatly influenced the content of this document. Particular thanks are extended to Mr Andrew Hobbs of DFID for his interest and advice on many aspects of the project.

With regard to the Indian case study trial, the authors wish to express their gratitude to Dr A Veeraragavan of the University of Bangalore and Deputy Inspector General M N Reddi of the Bangalore Police for their invaluable cooperation, assistance and advice. The authors also wish to thank Mrs Kalpana Kar and Mr Sanjeev Kumar of the Bangalore Agenda Task Force (BATF), Assistant Commissioner of Police M T Naik, Mr R Jaiprasad (Chief Engineer) and Mr Rajmohan of Bangalore Mahanagara Palike (Bangalore City Corporation), Mr Rohit Baluja of the Institute of Road Traffic Education. Indeed, thanks are also due to all those individuals who took part in the stakeholder seminar and other subsequent meetings.

For the Indonesia case study the authors' gratitude is extended to Mr. Subagus Dwi Nurjaya, Mr. Imam Santoso and Mr. Muhammad Idris of the Institute of Road Engineering (IRE), Bandung, Mr. Karyono, Head of Local Highway Dept., Mr. Djajadi MM, Head of Local Land Transport Dept., DLLAJ and Ir. Karyono of Bina Marga, and Sgt. Donato of the Cirebon Traffic Police for their invaluable cooperation, assistance and advice. The authors also wish to thank all those other representatives from Local Government, Highways Department, City Engineer (City Board), Traffic Police, Department of Gardening and Graveyards, Public Transport (Organda), Chamber of Commerce and Industry, Port Authority, Health Department; Education Department, Fire Department, Forum for a Nice Cirebon (a NGO), Street Vendor Association (from Swakarty), and Neighbourhood Association (Siliwangi) for taking part in the stakeholder discussions.

Finally the authors wish to thank all those members of TRL staff, notably Ms Stephanie Kirk, Ms Annabel Davis, Mr Nicholas Greaves, Mr Archie Mackie and Mrs Lena Weaver who provided valuable advice or contributed to the production of this Guide.

11 REFERENCES

- Abbess C, D Jarrett, C C Wright (1981).** *Accidents at blackspots: estimating the effectiveness of remedial treatment, with special reference to the 'regression-to-mean' effect.* Traffic Engineering. & Control, **22** 10 .
- Aeron-Thomas, A (2000).** *Under-reporting of road traffic casualties in low income countries.* TRL Report PR/INT/199/00 (Unpublished). TRL Limited, Crowthorne
- Asmussen, E (1984).** *International calibration study of traffic conflict techniques.* NATO ASI Series. Springer-Verlag, Heidelberg.
- AASHTO (1992).** *Guidelines for Traffic Data Programs.* American Association of State Highway and Transportation Officials. International Library Service, Provo, USA.
- Austrroads (1994).** *Road Safety Audit.* Publication No: AP 30/94. ISBN 0 85588 455X. Austrroads, Sydney.
- Baguley, C J (1995).** *Interim Guide on identifying, prioritising and treating hazardous locations on roads in Malaysia.* Jabatan Kerja Raya, Ministry of Public Works, JKR 20708-0022-95, Kuala Lumpur.
- Barrett, R (1989).** *National, Urban and City Road Safety Comparisons.* 2nd African Road Safety Congress – Addis Ababa 16th – 20th October 1989 (pp340). ECA/OECD.
- Barwell, I. (1988)** *Guidelines for remote area transport and socio-economic surveys.* Transport, Communications and Tourism Division, United Nations Economic and Social Commission for Asia and the Pacific. (Section 2.5 p9)
- Boyle, A J and C C Wright (1984).** *Accident migration after remedial treatment at accident blackspots.* Traffic Engng. & Control, **25**, 5 .
- Brindle, R E (1986).** *The relationship between traffic management, speed and safety in neighbourhoods.* In: Proceedings of 13th ARRB Conference 13(a), pp90-102. Australian Research Board, Vermont South.
- Chambers, R. and Gujit, I (1995).** *PRA – five years later. Where are we now?* Forests, Trees and People Newsletter No. 26/27, Uppsala, Sweden.
- County Surveyors Society et al, (1994).** *Traffic calming in practice.* ISBN: 1 899650 008, IRRD 871907. Landor Publishing Ltd., London.
- Denzin, N and Y Lincoln (eds) (1994),** *Handbook of Qualitative Research.* Sage Publications, London/New Delhi.
- Department for Transport (2000).** *Highways Economics Note No1: 2000.* DfT, Wetherby, UK
- Department for Transport (2001).** *Gloucester Safer City.* Product code 01 TSP 0456, DfT, Wetherby UK

- European Commission (2001).** *The DUMAS Project, Developing Urban Management And Safety. Research Report, 19 March 2001* Available on: <http://www.trl.co.uk/dumas/dumas.htm>
- Grayson, G (1996).** *Behaviour adaptation: a review of the literature.* TRL Report 254. TRL Limited, Crowthorne.
- Hass-Klau, C, Nold I, Bocker, G and G Crampton (1992).** *Civilised Streets: a guide to traffic calming.* Environmental & Transport Planning. 10 Clermont Terrace, Brighton BN16SH
- Hauer, E, and P Byer (1983).** *Bias-by-selection: the accuracy of an unbiased estimator.* Accident Analysis & Prevention. **15**, 5, pp 323-328.
- Hills, B L Baguley, C J and S J Kirk (2002)** *Final Report DFID Project R6891. Cost and Safety Efficient Design of Rural Roads in Developing Countries*, and four CaSE Design Notes. TRL Limited, Crowthorne. Available on <http://www.tranport-links>
- IHT (1990).** *Guidelines for the Safety Audit of Highways.* Institution of Highways and Transportation, London
- IHT (1991).** *Guidelines for Urban Safety Management.* Institution of Highways and Transportation, London
- Jacobs G D, Aeron-Thomas A and Astrop A (2000).** *Estimating global road fatalities.* TRL Report 445. TRL Limited, Crowthorne.
- Kulmala, R (1994).** *Measuring the safety effect of road measures at junctions.* Accident Analysis & Prevention. 26 6
- Lines, C (1992).** *Urban Safety management* VTI Rapport, In: Conference Proceedings: Road Safety In Europe, Berlin, Germany Sept 30 – Oct 2 1992
- Lines, C (1996).** *Urban Safety Management – the Future?* TRL Staff Paper September 1996. TRL Limited, Crowthorne
- Lines, C (1998).** *Urban Safety Management.* Supplement to journal of Highways and Transportation, April 1998
- Lines, C (1999).** *The DUMAS Project - Developing Urban Management and Safety* European Transport Conference, Cambridge 27-29 September 1999, Proceedings of Seminar D, PTRC
- Mackie, A and H Ward (1996).** *Gloucester Safety Town – Strategy.* TRL Unpublished Report PR/TT/075/96. TRL Limited, Crowthorne
- Maher, M J and L J Mountain (1988).** *The identification of accident blackspots: comparison of current methods.* Accident Analysis & Prevention 20 2
- Mikkelsen, B (1995).** *Methods for development work and research: a guide for practitioners.* Sage Publications, London/New Delhi.
- Mountain, L, and B Fawaz (1992).** *The effects of engineering measures on safety at adjacent sites.* Traffic Engineering. & Control, 33, 1

- Mountain, L, Fawaz, B and L Sineng (1992).** *The assessment of changes in accident frequencies on link segments: a comparison of four methods.* Traffic Engineering. & Control, 33 7.
- Mountain, L (1998).** *Regression, migration and trend: road accident reductions aren't always what they seem.* <http://www.safety98.org/html/papers7/d-4.htm>
- NIMHANS (1999).** *Annual Report.* National Institute of Mental Health & Neurological Science, Bangalore
- OECD Scientific Expert Group (1990).** *Integrated traffic safety management in urban areas.* Organisation for Economic Co-operation and Development, Paris
- Persaud, B (1987).** *Migration of accident risk after remedial treatment at accident blackspots.* Traffic Engineering. & Control, 28, 1.
- PIARC (2001).** *Road safety audits.* ISBN 2-84060-135-4. PIARC – World Road Association. La Grande Arche, Paris.
- Proctor, S, Belcher, M and P Cook (2001).** *Practical road safety auditing.* ISBN 0-7277-2938 TMS Consultancy, Thomas Telford Ltd, London.
- Radin Umar, R S, Mackay, G M and B L Hills (1995).** *Preliminary analysis of motorcycle accidents: short-term impacts of the running headlight campaign and regulation in Malaysia.* Journal of Traffic Medicine Volume 23, ISSN 034-5564, .
- RoSPA (1992).** *Road Safety Engineering Manual .* Royal Society for the Prevention of Accidents, Birmingham UK
- Schermers, G (1996).** *National Guidelines for Traffic Calming.* Department of Transport, Pretoria
- Simmonds, A G (1981)** The effects on vehicle speeds of roadside safety posters. *Traffic Engineering & Control*, 22(8/9), 480-485.
- Taylor, M C, Lynam, D A and A Baruya (2000).** The effects of drivers speed on the frequency of road accidents. TRL Report 421. TRL Limited, Crowthorne.
- TRL (1965).** *Research on road traffic.* HMSO, Wetherby, UK.
- TRL (1993).** *Urban Traffic Surveys.* Overseas Road Note 11. TRL Limited, Crowthorne.
- TRL (1997).** *Road Safety Education in Developing Countries: Guidelines for good practice in primary schools.* Overseas Road Note 17: TRL Limited, Crowthorne.
- TRL, Ross Silcock and Overseas Development Administration (1991).** *Towards safer roads in developing countries: A guide for planners and engineers.* TRL Limited, Crowthorne.
- Trimpop, R M, & G J S Wilde (1994).** *Challenges to accident prevention: the issue of risk compensation behaviour.* STYX Publications, Postbus 2659, 9704 CR Groningen, The Netherlands.

- UN (2002).** *World Urbanization Prospects: the 2001 revision*. ESA/WP.173. United Nations Population Division, UN Secretariat, New York
- UNCHS (1996).** *An urbanising world: global report on human settlements*. United Nations Centre for Human Settlements. Oxford University Press, Oxford
- UNCHS (1999)** *Human Settlements Conditions and Trends*. Global Urban Observatory and Statistics Unit. UNCHS (Habitat).
- UNCHS (1999).** *Human Settlements Conditions and Trends*. Global Urban Observatory and Statistics Unit. UNCHS (Habitat): www.unchs.org/habrdd/CONTENTS.html.
- Wardrop, J G and G Charlesworth (1954).** *A method of estimating speed and flow of traffic from a moving vehicle*. Proceedings of the Institution of Civil Engineers, Part II, Vol. 3, pp. 158-171
- WBCSD (2001).** *Mobility 2001: world mobility at the end of the twentieth century and its sustainability*. World Business Council for Sustainable Development.
- Webster, D C and A M Mackie (1996).** *Review of traffic calming schemes in 20mph zones*. TRL Report 215. TRL Limited, Crowthorne.
- Wells, G (1979).** *Traffic engineering, an introduction*. Second edition. Charles Griffin & Co Ltd, High Wycombe.
- World Health Organisation (1997).** *World health statistics, 1996*. Geneva.
- World Bank (2000).** *Attacking poverty*. World Development Report 2000/2001. World Bank, Washington D.C
- World Bank (2001a).** *Urban poverty*. Poverty Reduction Strategy Sourcebook: Draft. World Bank, Washington D.C
- World Bank (2001b).** *Cities on the move: a World Bank urban transport strategy review*. World Bank, Washington D.C.
- World Bank (2001c).** *Study on gender dimension in Dhaka urban transport project*. World Bank GenderNet website: www.worldbank.org/gender/transport
- Wright, C C, Abbess, C R and D F Jarrett (1986).** *Estimating the regression-to-mean effect associated with road accident blackspot treatment: towards a more realistic approach*. Accident Analysis & Prevention. 20, 3, pp 199-214.
- Wright, C C and A J Boyle (1987).** *Road accident causation and engineering treatment: a review of current issues*. Traffic Engineering & Control. 28 9

Appendix A

APPENDIX A DEFINING URBAN POVERTY

Appendix A

DEFINING URBAN POVERTY

The United Nations Charter, the Universal Declaration of Human Rights, and the World Summit on Social Development, amongst others, have reconfirmed the basic economic, social, political, civil and cultural rights of the global poor including adequate standards of living, food, housing, education, health, work and social security.

The World Development Report on *Attacking Poverty* (2000) refers to an evolving paradigmatic shift from the 'traditional' definition of poverty, that being material deprivation measured by an appropriate concept of income or consumption, to one which captures intangible measures of poverty such as low achievements in education and health, vulnerability and exposure to risk, as well as voicelessness and powerlessness. Indeed, the World Bank's Poverty Reduction Strategy Paper Sourcebook describes five key dimensions of poverty: income/consumption, health,

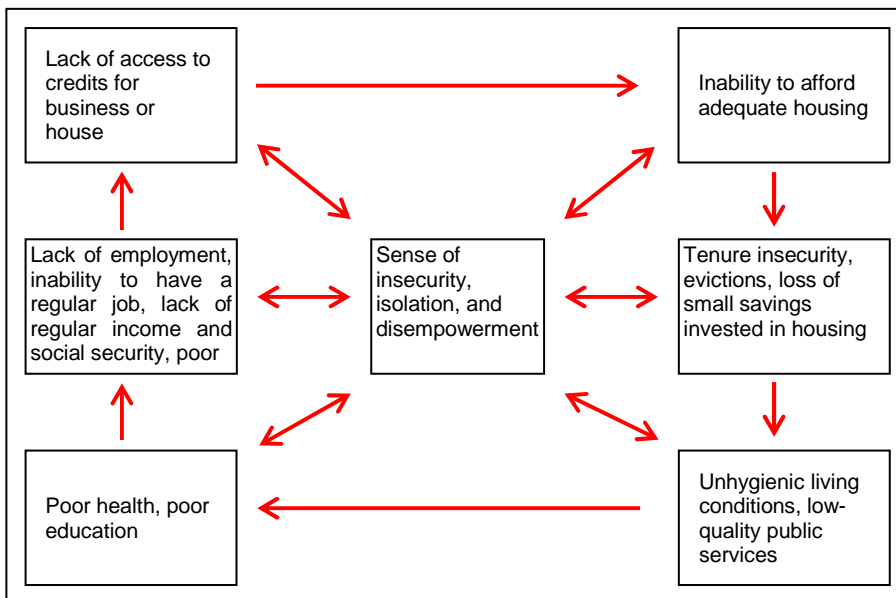

education, security and empowerment. Urban poverty is often characterised by cumulative deprivations, whereby one dimension of poverty is the cause or contributor of another dimension, as demonstrated in **Figure A-1**:

Source: World Bank (2001a)

Figure A-1: Cumulative impacts of urban poverty

Traditionally, poverty has been defined in terms of shortfalls of consumption or income. The 'absolute' poverty line is taken as the income necessary to afford a minimum nutritionally adequate diet plus essential non-food requirements for a household of a given size. The common method for setting the poverty line proceeds by fixing a food intake in calories, and then finding the consumption expenditure or income level at which a person typically attains that food intake (see **Table A-1** for varying degrees of urban poverty).

Appendix A

Table A-1: Different aspects of urban poverty

CUMULATIVE URBAN POVERTY INDEX

1	<i>Inadequate income</i> (and so inadequate consumption of basic necessities)					
2	<i>Inadequate income</i> (and so inadequate consumption of basic necessities)	<i>Limited asset base</i> (non-material and material including housing) for individuals, households or communities				
3	<i>Inadequate income</i> (and so inadequate consumption of basic necessities)	<i>Limited asset base</i> (non-material and material including housing) for individuals, households or communities	<i>Inadequate provision of 'public' infrastructure and services</i> (piped water, sanitation, drainage, health care, schools, emergency services etc), no 'safety net'			
4	<i>Inadequate income</i> (and so inadequate consumption of basic necessities)	<i>Limited asset base</i> (non-material and material including housing) for individuals, households or communities	<i>Inadequate provision of 'public' infrastructure and services</i> (piped water, sanitation, drainage, health care, schools, emergency services etc), no 'safety net'	<i>Inadequate protection from the law</i> – for instance civil and political rights, health and safety in the workplace, environmental legislation, protection from violence		
5	<i>Inadequate income</i> (and so inadequate consumption of basic necessities)	<i>Limited asset base</i> (non-material and material including housing) for individuals, households or communities	<i>Inadequate provision of 'public' infrastructure and services</i> (piped water, sanitation, drainage, health care, schools, emergency services etc), no 'safety net'	<i>Inadequate protection from the law</i> – for instance civil and political rights, health and safety in the workplace, environmental legislation, protection from violence	<i>Voicelessness and powerlessness</i> within political system – no right or possibility to receive entitlements, make demands and get a fair response	
6	<i>Inadequate income</i> (and so inadequate consumption of basic necessities)	<i>Limited asset base</i> (non-material and material including housing) for individuals, households or communities	<i>Inadequate provision of 'public' infrastructure and services</i> (piped water, sanitation, drainage, health care, schools, emergency services etc), no 'safety net'	<i>Inadequate protection from the law</i> – for instance civil and political rights, health and safety in the workplace, environmental legislation, protection from violence	<i>Voicelessness and powerlessness</i> within political system – no right or possibility to receive entitlements, make demands and get a fair response	<i>Exploitation and discrimination</i> (eg. by gender, ethnicity, age etc)

Source: Mitlin and Satterthwaite (2000)

Appendix A

12 References

Mitlin, D. and Satterthwaite, D. (2000). *'Urban poverty: some thoughts about its scale and nature and about responses to it'* in Yusuf, S. Wu, W. and Evenett, S. (Editors). *The challenge of globalisation: international and local dimensions of development*. World Bank, Washington D.C

World Bank (2001a). *Urban poverty*. Poverty Reduction Strategy Sourcebook: Draft. World Bank, Washington D.C

World Bank (2000). *Attacking poverty*. World Development Report 2000/2001. World Bank, Washington D.C

Appendix B
STATISTICAL TESTS

APPENDIX B.1

B.1 Student's t-test for comparison of samples (eg. sets of mean speed measurements)

To determine whether the mean speed of one set of speed measurements is significantly different from another (ie. between a "before" and "after" study), it is appropriate to use Student's two-tailed t-test, making the reasonable assumption that the variances of the two sets of measurements are drawn from the same population. The null hypothesis is thus that there is no difference in the means (ie. that drivers' speed has not been affected by the scheme). It is first necessary to determine the standard deviation of the difference in means.

Let b_1, b_2, \dots, b_{nb} be the Before speed readings
and a_1, a_2, \dots, a_{na} be the After speed readings

We then calculate the equations below:

$$\text{Means : } \bar{b} = \frac{\sum(b_i)}{n_b}, \quad \bar{a} = \frac{\sum(a_i)}{n_a}$$

$$\text{Standard deviation: } \sigma = \sqrt{\frac{\sum(a_i^2) - \frac{(\sum(a_i))^2}{n_a} + \sum(b_i^2) - \frac{(\sum(b_i))^2}{n_b}}{(n_a + n_b - 2)}}$$

$$t = \frac{\bar{a} - \bar{b}}{\sigma} \cdot \sqrt{\frac{n_a \times n_b}{n_a + n_b}}$$

Having found the value of t we need to look at a table of Student's t values (see page B.1-4), with $(n_a + n_b - 2)$ degrees of freedom. If the value of t exceeds that for the 5% level (the $t = 0.05$ column) we can be 95% confident that the true mean speed has changed.

Example

Assume that number of speed readings

before a scheme,	$n_b = 210$
and the mean,	$\bar{b} = 37 \text{ mile/h}$
sum of readings	$\sum b_i = 7770$
sum of squares	$\sum (b_i)^2 = 291,142$

Similarly, after a scheme,

$n_a = 220$
$\bar{a} = 33 \text{ mile/h}$
$\sum a_i = 7260$
$\sum (a_i)^2 = 243,760$

APPENDIX B.1

From the above equations,

$$\begin{aligned} \text{standard deviation, } \sigma &= \sqrt{\frac{243760 - (7260)^2 / 220 + 291142 - (7770)^2 / 210}{220 + 210 - 2}} \\ &= 18.299 \end{aligned}$$

$$\begin{aligned} t &= \frac{33 - 37}{18.299} \cdot \sqrt{\frac{220 \times 210}{220 + 210}} \\ &= 2.265 \end{aligned}$$

$$\begin{aligned} \text{for degrees of freedom, } \nu &= 220 + 210 - 2 \\ &= 428 \end{aligned}$$

As the **t** value is greater than 1.96 (for the large number of degrees of freedom), then we can say that the mean difference in mean speeds (a 4 mile/h reduction) is significant at the 5% level.

APPENDIX B.1

B.1.1 Table of t-distribution

Degrees of freedom, ν	t				
	0.10	0.05	0.02	0.01	0.001
1	6.314	12.706	31.821	63.657	636.619
2	2.920	4.303	6.965	9.925	31.598
3	2.353	3.182	4.541	5.841	12.941
4	2.132	2.776	3.747	4.604	8.610
5	2.015	2.571	3.365	4.032	6.859
6	1.943	2.447	3.143	3.707	5.959
7	1.895	2.365	2.998	3.499	5.405
8	1.860	2.306	2.896	3.355	5.041
9	1.833	2.262	2.821	3.250	4.781
10	1.812	2.228	2.764	3.169	4.587
11	1.796	2.201	2.718	3.106	4.437
12	1.782	2.179	2.681	3.055	4.318
13	1.771	2.160	2.650	3.012	4.221
14	1.761	2.145	2.624	2.977	4.140
15	1.753	2.131	2.602	2.947	4.073
16	1.746	2.120	2.583	2.921	4.015
17	1.740	2.110	2.567	2.898	3.965
18	1.734	2.101	2.552	2.878	3.922
19	1.729	2.093	2.539	2.861	3.883
20	1.725	2.086	2.528	2.845	3.850
21	1.721	2.080	2.518	2.831	3.819
22	1.717	2.074	2.508	2.819	3.792
23	1.714	2.069	2.500	2.807	3.767
24	1.711	2.064	2.492	2.797	3.745
25	1.708	2.060	2.485	2.787	3.725
26	1.706	2.056	2.479	2.779	3.707
27	1.703	2.053	2.473	2.771	3.690
28	1.701	2.048	2.467	2.763	3.674
29	1.699	2.045	2.462	2.756	3.659
30	1.310	2.042	2.457	2.750	3.646
40	1.684	2.021	2.423	2.704	3.551
60	1.671	2.000	2.390	2.660	3.460
120	1.658	1.980	2.358	2.617	3.373
∞	1.645	1.960	2.326	2.576	3.291

APPENDIX B.2

B.2 Kolmogorov-Smirnov test

The 'two-tailed' Kolmogorov-Smirnov test determines whether two independent samples have been drawn from the same population (or from populations with the same distribution). If the two samples have in fact been drawn from the same population (the null hypothesis), then the cumulative distributions of both samples may be expected to be fairly close to each other, i.e. they should show only random deviation from the population distributions. If the two sample cumulative distributions are too far apart at any point this suggests that they come from different populations. Thus a large enough deviation between the two sample cumulative distributions is evidence for rejecting the null hypothesis.

Let $S_{Na}(x)$ be the observed cumulative step function of the first speed sample i.e. $S_{Na}(x) = K/N_a$ where K is the number of vehicles equal to or less than x km/h and N_a is the total number of the sample. Let $S_{Nb}(x)$ be the cumulative step function of the second sample. Now the Kolmogorov-Smirnov two-tail test focuses on the maximum deviation, D .

$$D = \text{maximum } |S_{Na}(x) - S_{Nb}(x)| \dots\dots\dots(1)$$

For large samples ($N > 40$) Kolmogorov-Smirnov tables show that the value of D must equal or exceed the value of:

$$1.36 \cdot \sqrt{\frac{N_a + N_b}{N_a N_b}}$$

to reject the null hypothesis at the 5 per cent level, that is, that they are not from the same population.

The 'one-tailed' Kolmogorov-Smirnov test determines whether the two samples have been drawn from the same population or whether the values of one sample are stochastically larger than the values of the population from which the other sample was drawn. The maximum deviation is again calculated using equation (1) and the significance of the observed value of D can be computed by reference to the chi-squared distribution. It has been shown that for large samples:

$$\chi^2 = 4D^2 \frac{N_a N_b}{N_a + N_b}$$

has a sampling distribution which is approximated to the chi-square distribution with two degrees of freedom. A chi-squared table for reference is given on page B.2-3.

Example

Let us assume that *Before* and *After* speed measurements have given the following two distributions: -

APPENDIX B.2

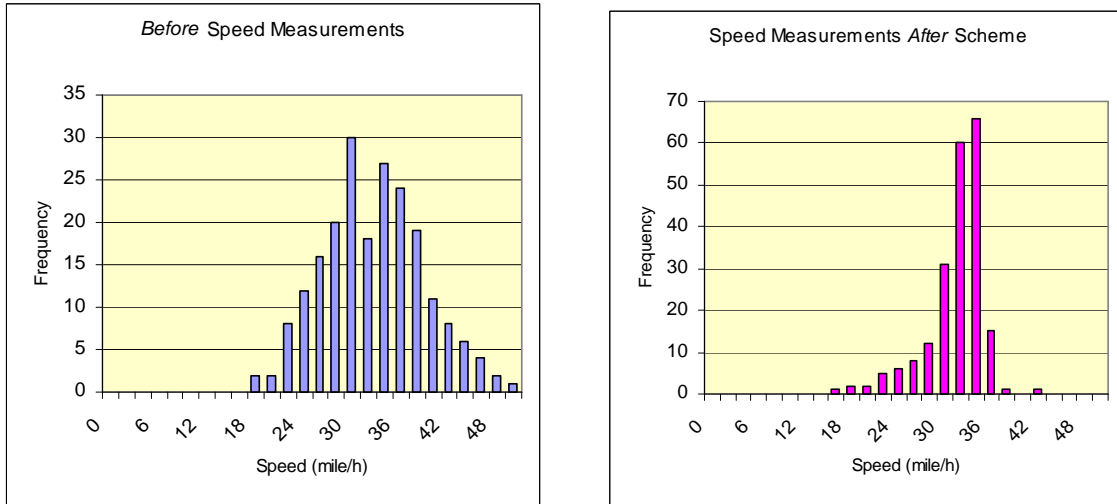

If we plot these as cumulative speed distributions:

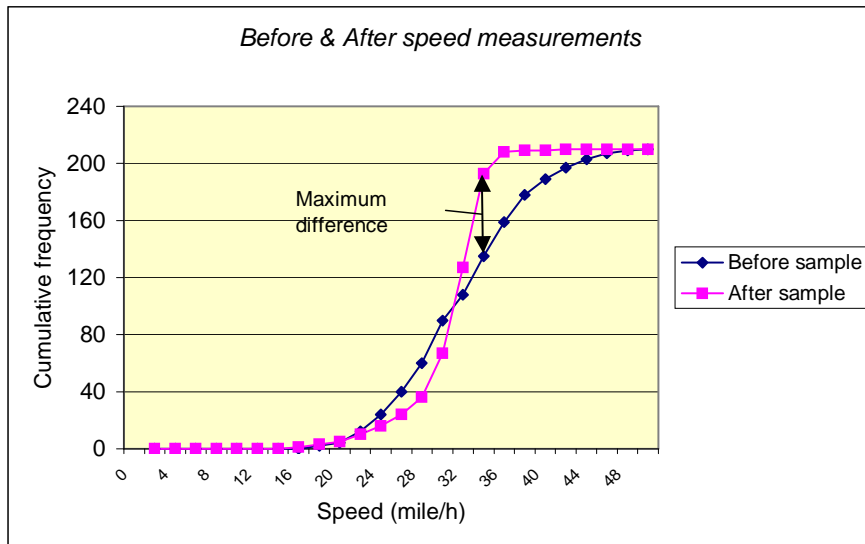

The observed cumulative step function of the *After* speed sample,

$$S_{Na}(x) = K/N_a = 193/210 \\ = 0.919$$

For the *Before* sample,

$$S_{Nb}(x) = K/N_b = 135/210 \\ = 0.643$$

The maximum deviation, $D = 0.919 - 0.643 \\ = 0.276$

The Kolmogorov-Smirnov value at the 5 % level
 $= 1.36 (210+210/(210 \times 210))^{1/2}$
 $= 0.133$

which is less than the maximum deviation, and thus we can reject the null hypothesis at the 5% level. That is, in this case there is a significant difference between the two speed samples.

APPENDIX B.2

B.2.1 Table of χ^2

Degrees of Freedom ν										
	0.99	0.98	0.95	0.90	0.50	0.10	0.05	0.02	0.01	0.001
1	0.000	0.001	0.004	0.015	0.455	2.710	3.840	5.410	6.640	10.830
2	0.020	0.040	0.103	0.211	1.386	4.610	5.990	7.820	9.210	13.820
3	0.115	0.185	0.352	0.584	2.366	6.250	7.820	9.840	11.340	16.270
4	0.297	0.429	0.711	1.064	3.357	7.780	9.490	11.670	13.280	18.470
5	0.554	0.752	1.145	1.610	4.351	9.240	11.070	13.390	15.090	20.520
6	0.872	1.134	1.635	2.204	5.350	10.650	12.590	15.030	16.810	22.460
7	1.239	1.564	2.167	2.833	6.350	12.020	14.070	16.620	18.480	24.320
8	1.646	2.032	2.733	3.490	7.340	13.360	15.510	18.170	20.090	26.130
9	2.088	2.532	3.325	4.168	8.340	14.680	16.920	19.680	21.670	27.880
10	2.558	3.059	3.940	4.865	9.340	15.990	18.310	21.160	23.210	29.590
11	3.050	3.610	4.570	5.580	10.340	17.280	19.680	22.620	24.730	31.260
12	3.570	4.180	5.230	6.300	11.340	18.550	21.030	24.050	26.220	32.910
13	4.110	4.760	5.890	7.040	12.340	19.810	22.360	25.470	27.690	34.120
14	4.660	5.370	6.570	7.790	13.340	21.060	23.690	26.870	29.140	36.120
15	5.230	5.990	7.260	8.550	14.340	22.310	25.000	28.260	30.580	37.700
16	5.810	6.610	7.960	9.310	15.340	23.540	26.300	30.000	32.000	39.250
17	6.410	7.260	8.670	10.090	16.340	24.770	27.590	31.000	33.410	40.790
18	7.020	7.910	9.390	10.870	17.340	25.990	28.870	32.350	34.810	42.310
19	7.630	8.570	10.120	11.650	18.340	27.200	30.140	33.690	36.190	43.820
20	8.260	9.240	10.850	12.440	19.340	28.410	31.410	35.020	37.570	45.320
21	8.900	9.910	11.590	13.340	20.340	29.610	32.670	36.340	38.930	46.800
22	9.540	10.600	12.340	14.040	21.340	30.810	33.920	37.660	40.290	48.270
23	10.200	11.290	13.090	14.850	22.340	32.010	35.170	38.970	41.640	49.730
24	10.860	11.990	13.850	15.660	23.340	33.200	36.420	40.270	42.980	51.180
25	11.520	12.700	14.610	16.470	24.340	34.380	37.650	41.570	44.310	52.620
26	12.200	13.410	15.380	17.290	25.340	35.560	38.890	42.860	45.640	64.050
27	12.880	14.120	16.150	18.110	26.340	36.740	40.110	44.140	46.960	55.480
28	13.560	14.850	16.930	18.940	27.340	37.920	41.340	45.420	48.280	56.890
29	14.260	15.570	17.710	19.770	28.340	39.090	42.560	46.690	49.590	58.300
30	14.950	16.310	18.490	20.600	29.340	40.260	43.770	47.960	50.890	59.700
40	22.164	23.838	26.509	29.051	39.335	51.805	55.759	60.436	63.691	73.402
50	29.707	31.664	37.689	37.689	49.335	63.167	67.505	72.613	76.154	86.661
60	37.485	39.699	43.188	46.459	59.335	74.397	79.082	84.580	88.379	99.607
70	45.442	47.839	51.739	55.329	69.334	85.527	90.531	96.388	100.425	112.317
80	53.539	56.213	60.391	64.278	79.334	96.578	101.880	108.069	112.329	124.839
90	61.754	64.634	69.126	73.291	89.334	107.565	113.145	119.646	124.116	137.208
100	70.065	73.142	77.929	82.358	99.334	118.498	124.342	131.142	135.807	149.449

APPENDIX B.3

B.3 The Tanner k test

The Tanner k test can be used to show how the accident numbers at a site change relative to control data.

For a given site or group of similarly treated sites, let:-

a = before accidents at site
 b = after accidents at site
 c = before accidents at control
 d = after accidents at control

then:-

$$k = \frac{b/a}{d/c}$$

or, if any of the frequencies are zero then $\frac{1}{2}$ should be added to each, ie:

$$k = \frac{(b + \frac{1}{2})(c + \frac{1}{2})}{(a + \frac{1}{2})(d + \frac{1}{2})}$$

If $k < 1$ then there has been a *decrease* in accidents relative to the control;
 if $k = 1$ then there has been *no change* relative to the control; and
 if $k > 1$ then there has been an *increase* relative to the control.

The percentage change at the site is given by:-

$$(k - 1) \times 100\%$$

Example

Let us assume that the table below gives the annual injury accident totals for a priority T-junction in a semi-urban area which had Stop signs on the minor road originally, but where a roundabout was installed three years ago. The control data used are accidents on all other priority junctions in the Authority over exactly the same 3-year before and 3-year after periods.

Injury accident totals in 3-year periods at treated site and controls

	<i>Site</i>	<i>Control</i>	<i>Total</i>
Before	20 (a)	418 (c)	438 (g)
After	6 (b)	388 (d)	394 (h)
Total	26 (e)	806 (f)	832 (n)

Using the notation and formula above,

$$k = \frac{6/20}{388/418} = 0.323$$

Therefore, as $k < 1$ there has been a decrease in accidents relative to the controls of:

$$(k - 1) \times 100\% = 67.7\%$$

APPENDIX B.4

B.4 The Chi-Squared test

This test can be used to determine whether the change in accidents was produced by the treatment or whether this occurred by chance. This test thus determines whether the change is statistically significant. The test is based on a table showing both the observed values of a set of data (O) and the corresponding expected values (E). The chi-squared statistic is then given by

$$\chi^2 = \sum_{i=1, k=1}^{n, m} \frac{(O_{ij} - E_{ij})^2}{E_{ij}}$$

where O_{ij} is the observed value in column j , row i of the table
 E_{ij} is the expected value in column j , row i of the table
 m is the number of columns
 n is the number of rows

A chi-squared table (as on page B.2-3) is then used to look up this value which shows the probability that the 'expected' value and the 'observed' values are drawn from the same population. The number of degrees of freedom is also required and this is given by:-

$$\text{Degrees of freedom, } \nu = (n-1)(m-1).$$

For a site accident evaluation, where its accidents are compared in similar periods before and after treatment with a set of control sites for the same periods, we have a 2 by 2 contingency table (2 columns and 2 rows with degrees of freedom = 1). For the test to be valid the value of any cell of the table should not ideally be less than 5. However, when testing an individual site for accidents then this situation can, of course, be quite common and so a slight modification (known as Yates' correction) is normally applied.

Example

Consider the same example as given in Appendix B3 :

Injury accident totals in 3-year periods at treated site and controls

	Site	Control	Total
Before	20 (a)	418 (c)	438 (g)
After	6 (b)	388 (d)	394 (h)
Total	26 (e)	806 (f)	832 (n)

For such a 2x2 table, a special simplified formula can be used for chi-squared which, using the notation from the above table, is:-

$$\chi^2 = \frac{\left(|ad - bc| - \frac{n}{2} \right)^2 \cdot n}{efgh}$$

Its value is then compared with values in the Chi-squared table (page B.2-3) with degrees of freedom, $\nu = 1$, and if it is just greater than a particular value it is said to be statistically significant at at least that percentage level.

$$\chi^2 = \frac{\left(|20 \times 388 - 6 \times 418| - \frac{832}{2} \right)^2 \times 83}{26 \times 806 \times 438 \times 394}$$

$$\chi^2 = 5.38$$

APPENDIX B.4

Now looking at the chi-squared distribution table (page B.2-3) and the first line (one degree of freedom, $\nu = 1$), the value for chi-square of 5.38 lies between 3.84 and 5.41. This corresponds to a value of significance level (on the column header line) between 0.05 and 0.02, which is normally quoted as greater than the lower level, ie. better than the 5% level of significance.

This means that there is only a 5% likelihood (or 1 in 20 chance) that the change in accidents is due to random fluctuation. Another way of stating this is that there is a 95% (100%-5%) confidence that a real change in accidents has occurred at the junction.

The 5% level or better is widely accepted as the level in which the remedial action has certainly worked, though the 10% level can be regarded as an indication of an effect.

For groups of sites that have been given the same treatment, these can be grouped together and analysed using the chi-squared test as for a single site. This will enable the overall benefit to be evaluated, and any specific sites can be analysed separately.

APPENDIX B.5

B.5 Test for statistical significance between two proportions

This test is used to determine whether proportions (of accident types, or of any other characteristic) in a study area are significantly different from the proportion in a control area. The null-hypothesis tested is that the proportion from the sample is the same as the proportion from the control, and the test tells us if we can reject this hypothesis.

There are two situations to consider, firstly where the study area is not contained within the control area and secondly where it is within the control area.

Suppose that we are interested in the proportion of all accidents area that involve serious injury within a study as compared to a control area. We test the hypothesis that the proportions are the same. If the number of all accidents in the study area is n_s and in the control area is n_c , and we observe m_s serious accidents in the study area and m_c in the control area, then:

1. Study area not within control area

The proportion in the *Study* area is given by: $p_s = m_s / n_s$,
and the proportion in the *Control* area by: $p_c = m_c / n_c$
and the overall proportion in the *Total* area (both study and control areas) by:
$$p = (m_s + m_c) / (n_s + n_c)$$

The test statistic 't' is calculated by:

$$t = (p_s - p_c) / (p(1-p) (1/n_s + 1/n_c))^{1/2}$$

with $(n_s + n_c - 2)$ degrees of freedom. If the degrees of freedom are greater than 120, and t is greater than 1.96 then we can be 95% sure that the two proportions are from different populations.

2. Study area within control area

Suppose the study area is a local authority area and national data are being used as a control. Then, for the purposes of this test, the *Study* accidents need to be excluded from the *Control* and the numbers of accidents in the *Control* area is calculated as 'the *Total* (national) accidents - *Study* accidents'.

The proportion in the *Study* area is given by: $p_s = m_s / n_s$
and the proportion in the *Control* area by: $p_c = (m_c - m_s) / (n_c - n_s)$
and the overall proportion in the *Total* area by:
$$p = m_c / n_c$$

The test statistic 't' is calculated by:

$$t = (p_s - p_c) / (p(1-p) (1/n_s + 1/(n_c - n_s)))^{1/2}$$

with $(n_c - 2)$ degrees of freedom. If the degrees of freedom are greater than 120, and t is greater than 1.96 then we can be 95% sure that the two proportions are from different populations. (If n_c is large compared to n_s , then we can ignore the fact that the study area is within the national area and use method 1).

APPENDIX B.5

Example:

Suppose that we are interested in whether the proportion of accidents at rural junctions in the study area is different from the proportion nationally. Then consider the following (fictitious) data:-

	Rural junction accidents	All Rural accidents	Proportion at junctions
<i>Total accidents nationally</i>	32,000	80,000	0.400
<i>Study area</i>	3200	7750	0.4129

Since rural junction accidents are included within all rural accidents, approach 2 is the appropriate test. The null-hypothesis is that the proportion of rural accidents that are at junctions in the study area is the same as the proportion of accidents elsewhere in the country that are at junctions.

The proportion in the *Study* area is given by: $p_s = 3200/7750=0.4129$
 and the proportion in the *Control* area by: $p_c = (32,000-3200)/(80,000-7750)=0.3986$
 and the overall proportion in the *Total* area by: $p = 32,000/80,000=0.400$

The test statistic 't' is calculated by:

$$t = \frac{(0.4129-0.3986)}{(0.4*(1-0.4)*(1/7750+1/(80,000-7750)))^{1/2}}$$

$$= 2.44$$

with (80,000-2) i.e. 79,998 degrees of freedom

So since the number of degrees of freedom is greater than 120 and t is greater than 1.96, we can be at least 95% sure that the proportion of accidents at junctions in our rural study area is greater than the proportion at junctions on other rural roads. Therefore we would recommend that further investigations are carried out to try and explain this result (see Barker et al (1999) for a more detailed explanation of how to interpret the result).

APPENDIX B.6

B.6 Regression-to-the-mean correction

To correct for the regression-to-the-mean effect it is necessary to estimate the true underlying accident rate. Several statisticians have proposed ways of doing this, eg. Hauer (1992) extended the Empirical Bayes' model to estimate the true underlying accident rate and then based the evaluation on this rather than the raw data. However, an approach that is simpler to apply for a single site was described by Abbess et al (1981), in which they adjusted the data to correct for biases using assumptions about the distribution of accidents over a period of years.

Accident data must be gathered for similar sites to the treated site over the same time period: the control sites. Using this full dataset the mean number of accidents, a , and the variance of accidents $var(a)$ are calculated. The regression-to-the-mean effect, R (in per cent) was shown to be given by the following formula:-

$$R = \left(\frac{(A_t + A)n}{(n_t + n)A} - 1 \right) \cdot 100$$

where A = the number of accidents at the site over a period of n years

$$A_t = \frac{a^2}{(var(a) - a)}$$

$$n_t = \frac{a}{(var(a) - a)}$$

A_t and n_t are the estimates of the parameters of the statistical distribution showing the true underlying accident rates, ie. the probability distribution of the accident rate before any data are available. The main assumption is, therefore, that the study site with a particular accident history will behave in the same way as the set of all similar sites with the same accident history.

Example

Let us consider a junction, which has had an average of 15 accidents per year over the past 5 years. The site was widened, large new junction signing, splitter islands and STOP signs installed, after which the site has averaged 10 accidents per year over a similar period.

To correct for the regression-to-mean effect, we need to select similar uncontrolled junction sites with similar traffic flows. If all these sites have produced a mean, a , of 12.6 accidents per year with a variance, $var(a)$, of 2.91, then using the equation above, the input values are:-

$$\begin{aligned} n &= 5 \text{ (years)} \\ A &= 75 \text{ (accidents)} \\ A_t &= 12.6^2 / (2.91 - 12.6) = -16.38 \\ n_t &= 12.6 / (2.91 - 12.6) = -1.3 \end{aligned}$$

Thus the Regression effect:-

$$\begin{aligned} R &= \left(\frac{(-16.38 + 75)5}{(-1.3 + 5)75} - 1 \right) \cdot 100 \\ &= 5.2\% \end{aligned}$$

APPENDIX B.6

That is, during the after period we would expect that if nothing were done to the site, the accidents would reduce by 5.2 per cent, or to 14.25 accidents per year. Thus it is the figure of 14.25 accidents per year that should be compared with the 10 accidents per year that actually occurred to determine whether the reduction in accident frequency due to the improvements is statistically significant .
